

McIntosh

BEST PERFORMANCE

GREATEST MUSICAL SATISFACTION

LONGEST PROTECTION

HIGHEST RELIABILITY

RIGOROUS QUALITY CONTROL

METICULOUS MANUFACTURE

PAINSTAKING ENGINEERING

LONG LIFE STYLING

HIGHEST VALUE AT TRADE TIME

McINTOSH PROTECTION

FIRST PROTECTION....

In these dark days of hurry up - percentage analysis - production rush - *and limited personal responsibility* the McIntosh policy of "Performance Limits" is a bit of bright blue sky. Every McIntosh instrument - - every one - - is tested to be equal to or better than the performance limits advertised. When a performance limit of 0.02% harmonic distortion is established for an instrument, McIntosh means that every, each, all of the instruments manufactured must be capable of performance to that limit - or better - - or your full purchase price will be refunded.

Here is one of the reasons McIntosh can make this promise: at McIntosh every product is 100% tested for maximum performance. We are not content knowing that 10% of our products are tested and meet the performance requirements established by our engineering group. We must know that every one meets its requirements. This rigorous pursuit of excellence takes time. At McIntosh more time means more care, more protection for you. There's no production rush at McIntosh.

The McIntosh investment in professional testing instruments is staggering. On a percentage basis McIntosh probably invests more of its sales dollars in testing facilities than anyone else in a like business. For instance, McIntosh has one professional distortion analyzer for every 10 employees. This kind of statistic is repeated for all sorts of test instruments. As new testing instruments are produced that update the McIntosh ability to know, McIntosh invests in them - - wave form analyzers - real time analyzers - lowest distortion signal generators - etc., etc. Even an FM transmitter so that the entire transmission/reception system can be analyzed.

"What does this mean to me?" you ask. Only through this impressive investment; through continuous testing and research; through product analysis; and endless measurement can we promise and deliver to you *reliability, long life, performance, highest value, and freedom from service.*

SECOND PROTECTION...

McIntosh Laboratory has great belief in its engineering, product development, manufacturing and quality control. To offer you strong evidence of this confidence McIntosh offers you a **FREE SERVICE CONTRACT**. During the life of the contract you can't spend one dime for service. McIntosh guarantees labor. It costs you nothing. The extended life of a McIntosh, the conservative ratings, and the sophisticated appearance make a McIntosh instrument a greater value when you are ready to trade. Step up to McIntosh now.

TABLE OF CONTENTS

MCINTOSH CARES ABOUT YOU.	2-3
FM DIRECTORY.	4-11
MCINTOSH AUDIO DIVISION	
RECEIVERS	MAC 1900 . . . 12-14
MCINTOSH LOUDSPEAKER DIVISION	
THE SOUND OF REALITY.	15
ML 1 C.	16
ML 2 C.	16
ML 4 C.	17
M L 2 M	1 6
ML 1 0 C	16
ENVIRONMENTAL	
EQUALIZERS	MQ 101. 18
MQ102.	18
MCINTOSH LABORATORY	
PREAMPLIFIERS	C 26. 19
C 28.	20-21
REMOTE CONTROL	
RELAY	SCR 2 21
MAXIMUM PERFORMANCE	
INDICATOR	MPI 4. 22-23
TUNERS	MR 78. 24-25
MR 77.	26
MR 74.	27
TUNER-PREAMPLIFIER	MX 113...28-29
PREAMPLIFIER-AMPLIFIER	
COMBINATION	MA 6100. 30
MONOPHONIC POWER	
AMPLIFIER	MC50. 32
STEREO POWER	
AMPLIFIERS	MC 250. 33
MC 2100.	33
MC 2505.	34
MC 2105.	34
MC 2300	35
STATION LOG.	36

Prices and designs subject
to change without notice

THE BEST STEREO

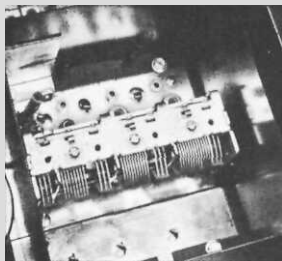

Tune weak, distant stations next to strong local stations easier. A seven section variable capacitor is the heart of the RF section. Four sections are used for FM and three for AM. By interleaving (FM-AM-FM-AM, etc.) spurious responses are significantly reduced and selectivity is substantially improved.



Excellent flexibility makes the MAC 1900 easier to set up. Pushbuttons are provided for your choice of any mode of operation. Use two tape recorders, 3 stereo speaker systems, seven modes of operation plus loudness compensation, muting, high and low filters,

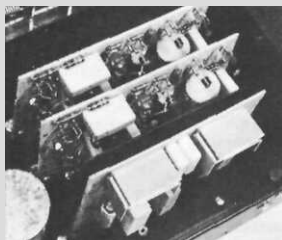

Each channel of the preamplifier is assembled on a plug-in high grade, low noise printed circuit card. A large quantity of negative feedback around the phono amplifier reduces noise and distortion and provides precision RIAA compensation for records.

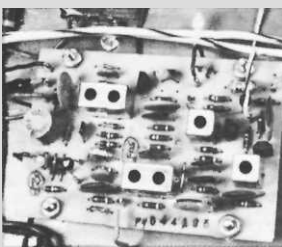

A new McIntosh engineering development has produced an AM circuit that has equal sensitivity across the entire band. Selectivity and image rejection have been maximized across the band. A patent application has been made for this new and superior AM tuner circuit.



Use and hear AM as never before. The MAC 1900 has a high quality loopstick AM antenna. It can be rotated for maximum performance, optimum signal reception and minimum interference. Each MAC 1900 loopstick is tuned for optimum performance. Custom matching maximizes performance. You can mount the receiver in any position without the sacrifice of sensitivity.



There's more real power and more protection. The power transistors are mounted on oversized black anodized heat sinks. Under normal operation the transistors will operate at low temperature. The power transistors used in the output circuits are selected for their high power dissipation capability, wide frequency response and large "safe operating area."

FM

A dual insulated gate metal oxide silicon field effect transistor (MOS-FET) is used as the first and second RF amplifier. The MOS-FET greatly reduces the cross-modulation products over a wider dynamic range. Wider dynamic range permits acceptance of up to 12 RF volts without overload or increased distortion!

The dual *QUAD-TUNED* IF filter has unusual adjacent channel selectivity and low distortion. The *QUAD-TUNED* IF filter has equal time delay in its pass band region. All other IF filters have delay distortion, as much as 100% of the 10.7 MHz transit delay. The MAC 1900 has less than 1.0% delay distortion from antenna input to discriminator output! You get overall lower distortion performance.

A particular advantage of the McIntosh multiplex circuit is the elimination of the critical adjustment in commonly used circuits. The L-R sidebands are detected then automatically matrixed with the L+R carrier. This yields the left and right program with maximum separation!

Ultrasonic muting makes FM tuning easier. FM muting operates by detecting ultrasonic noise which is present between stations or when receiving a weak station.

AM

The *NEW*, superb AM circuit design has linear sensitivity and linear frequency response over the entire AM band. The *NEW* AM circuit has high sensitivity and excellent dynamic range. The *NEW* AM circuit will not be overloaded by strong local stations yet is sensitive enough to receive distant and weak stations with minimum noise. Response has been carefully tailored to deliver maximum quality with minimum noise.

The high sensitivity ferrite loopstick antenna is carefully tuned and trimmed to match each MAC 1900. After the individual matching process, the antenna is sealed to preserve the superior performance introduced by individualized matching. McIntosh has revived the lost art of designing superb AM.

PREAMPLIFIER

The preamplifier is an outstanding example of what the electronic designers have done to provide for highest quality with great flexibility in a space limited housing. It has unusually low noise and low distortion. For instance, you can play, record, and monitor on two tape recorders.

POWER AMPLIFIER

The low distortion and stability of the MAC 1900 power amplifier circuit allows it to be used with any dynamic or electrostatic speaker system. McIntosh output circuit with instantaneous current limiting totally protects you. This reserve power and complete protection allows safe operation with as many as three pairs of speakers, individually or all together! You have front panel switching for three stereo loudspeaker systems of any type!

RECEIVER IS THE *MAC* 1900

*you get more value
 you get more protection from service costs
 you get more electronic protection
 you get more real power
 you get more useful flexibility
 you get more results from new technology
 you get more pure pleasure*

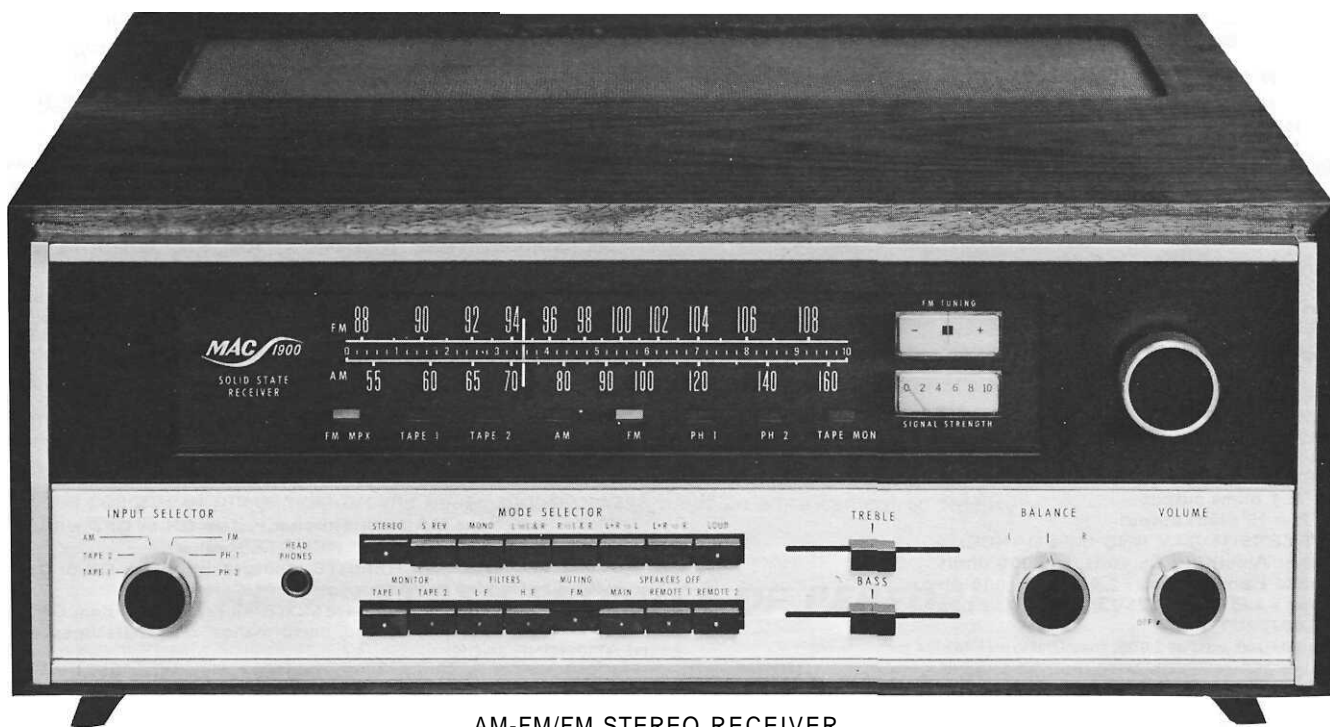

AM-FM/FM STEREO RECEIVER
 Shown in walnut veneer cabinet

TWO YEAR SERVICE CONTRACT

To make the value even greater, buy a McIntosh Audio product and get a free 2 YEAR SERVICE CONTRACT! An outstanding feature of the McIntosh Service Contract is the protection you get. Normal wear and tear as well as any manufacturing defect costs you nothing.



*Read about the
 Guaranteed
 Performance
 of the*



MAC 1900 Performance Limits

FM

PREAMPLIFIER AND POWER AMPLIFIER

McIntosh audio power ratings are in accordance with the Federal Trade Commission Regulation of November 4, 1974 concerning power output claims for amplifiers used in home entertainment products.

POWER OUTPUT:

55 watts minimum sine wave continuous average power output, per channel, both channels operating into 8 ohms load impedance, which is:

21.0 volts RMS across 8 ohms

30 watts minimum sine wave continuous average power output, per channel, both channels operating into 16 ohms load impedance, which is:

21.9 volts RMS across 16 ohms

40 watts minimum sine wave continuous average power output, per channel, both channels operating into 4 ohms load impedance, which is:

12.65 volts RMS across 4 ohms

OUTPUT LOAD IMPEDANCE:

4 ohms, 8 ohms, or 16 ohms

RATED POWER BAND:

20 Hz to 20,000 Hz

TOTAL HARMONIC DISTORTION:

0.2% maximum harmonic distortion at any power level from 250 milliwatts to rated power per channel from 20 Hz to 20,000 Hz, both channels operating

INTERMODULATION DISTORTION:

0.2% if instantaneous peak power output is twice rated continuous average power or less per channel with both channels operating for any combination of frequencies 20 Hz to 20,000 Hz

FREQUENCY RESPONSE: (at one watt Output)

20 Hz to 20,000 Hz +0.5 -0.5 dB

NOISE AND HUM:

Power Amplifier: 95 dB below rated output

Tape Input: 90 dB below rated output

Phono Input: 76 dB below 10 mV input

DAMPING FACTOR:

56 at 8 ohms output

112 at 16 ohms output

INPUT SENSITIVITY AND IMPEDANCE:

Power Amplifier: 2.5 volts, 100,000 ohms

Phono 1 and Phono 2: 2.0 mV, 47,000 ohms

Tape 1 and Tape 2: 250 mV, 250,000 ohms

TAPE OUTPUT:

Tuner: 1.0 volt at 100% modulation (FM)

Tape: 250 mV with rated input at 500 Hz

Phono: 1.2 volts with 1.0 mV input at 1000 Hz

BASS CONTROLS:

±16 dB at 20,000 Hz

TREBLE CONTROLS:

±16 dB at 20,000 Hz

L.F. FILTER:

Active filter, 12 dB per octave roll off below 50 Hz, down 18 dB at 20 Hz

H.F. FILTER:

Active filter, 12 dB per octave roll off above 7,000 Hz, down 13 dB at 20,000 Hz

AM

SENSITIVITY:

75 mV (external ant.)

SIGNAL TO NOISE RATIO:

45 dB minimum; 55 dB at 100% modulation

HARMONIC DISTORTION:

Will not exceed 1% at 30% modulation

ADJACENT CHANNEL SELECTIVITY:

30 dB minimum

IMAGE REJECTION:

65 dB minimum, 540 kHz — 1600 kHz

USEABLE SENSITIVITY:

2.5 microvolts at 100% modulation (±75 kHz deviation) for 3% total noise and harmonic distortion

SIGNAL TO NOISE RATIO:

70 dB below 100% modulation

HARMONIC DISTORTION:

Mono: Does not exceed 0.3% at 100% modulation ±75 kHz deviation; Stereo: Will not exceed 0.7%

AUDIO FREQUENCY RESPONSE:

±1 dB 20 Hz to 15,000 Hz with standard de-emphasis (75mS) and 19,000 Hz pilot filter

CAPTURE RATIO:

1.8 dB

SELECTIVITY:

55 dB alternate channel selectivity minimum

SPURIOUS REJECTION:

90 dB minimum

IMAGE REJECTION:

80 dB; 88 to 108 MHz (IHF)

STEREO SEPARATION:

34 dB at 1,000 Hz

SCA FILTER:

50 dB rejection from 67 kHz to 74 kHz, 275 dB per octave slope

FACILITIES AND FEATURES

BASS:

Slide control with mechanical detent for flat —16 dB to +16 dB at 20 Hz

TREBLE:

Slide control with mechanical detent for flat —16 dB to +16 dB at 20,000 Hz

LOUDNESS:

Pushbutton . . . , for loudness compensation or flat response

BALANCE:

Natural balance at center position, attenuation of left or right channel by rotating control

VOLUME:

Precision "tracked" at all listening levels. (0 to —65 dB) Does not change stereo balance as loudness is changed. The AC power ON/OFF switch is coupled with this control.

INPUT:

Six positions—TAPE 1, TAPE 2, AM, FM, PHONO 1 and PHONO 2

MODE:

Pushbutton—Left channel only to both speakers. Right channel only to both speakers, Stereo Reverse, Stereo, Mono: (L+R), L+R to right speaker only, and L+R to left speaker only

TAPE MONITOR:

Two pushbutton switches. Either of two tape recorders can be monitored by selecting the TAPE MONITOR 1 pushbutton or TAPE MONITOR 2 pushbutton. They are mechanically interlocked to accept only one pushbutton at the IN position at one time

SPEAKER:

Main—Switch the MAIN loudspeaker system ON or OFF without affecting the performance of REMOTE speakers.

Remote 1—Switch one REMOTE loudspeaker system ON or OFF without affecting the performance of MAIN speakers.

Remote 2—Switch a second REMOTE loudspeaker system ON or OFF without affecting the performance of MAIN speakers.

HEADPHONE JACK:

For listening with low impedance dynamic stereo headphones

GENERAL

POWER REQUIREMENTS:

120 volts, 50/60 Hz, 40 watts at zero signal output, 300 watts at rated output

SEMICONDUCTOR COMPLEMENT:

53 silicon field effect of bipolar transistors

3 integrated circuits

4 thyristors

39 silicon rectifiers and diodes

MECHANICAL

SIZE:

Front panel measures 16 inches wide (40.64 cm) by 5-1/2 inches high (13.97 cm). Chassis measures 15 inches wide (38.1 cm) by 5-1/8 inches high (13.02 cm) by 15 inches deep (38.1 cm) including back panel connectors. Knob clearance required is 1-1/2 inches (3.81 cm) in front of the mounting panel

FINISH:

Front panel is anodized gold with black

WEIGHT:

33 pounds (14.97 kg) net 46 pounds (20.87 kg) in shipping carton

From the **LOUDSPEAKER SCIENTISTS** at

McIntosh

THE SOUND of REALITY

WHAT IS THE MEASURE OF A LOUDSPEAKER?

A loudspeaker is a "sound imaging" device much the same as a photograph is a "visual imaging" device. You measure the excellence of a photograph by judging the coincidence of the visual image with reality. You measure the excellence of a loudspeaker by judging the coincidence of the sound image

with reality. After considering both the reality and the sound image you make the ultimate judgment based on what you hear. The most important thing a loudspeaker can do for you is to sound right the *first time* you listen to it, the *next time* you listen to it and *every time* you listen to it.

MAKING A REAL SOUND IMAGE

When you look in a perfectly flat mirror you will see an accurate image of yourself. If the mirror is bent then the accuracy of the image is altered. Mirrors can have other accuracy problems. They can be tinted so that the color coincidence of the object and the image is altered. In addition, the image may correspond in shape and size for one color but be out of shape or size for another color. Optical and sound imaging devices have analogous problems. Considering these facts it is possible to state the concept of image fidelity: *the image should coin-*

cide with the object in every detail. It should be no more nor no less.

Applying the image fidelity concept to a sound system requires a statement like this: We should hear the original sound - nothing subtracted - nothing added!

To the eternal credit of sound scientists and engineers most of the links in the sound imaging chain have reached a high level of perfection. The loudspeaker has been the last link in need of an advancement to fidelity.

THE MCINTOSH PROMISE OF PERFORMANCE

A McIntosh Loudspeaker is a promise of a new psycho-acoustic experience — the experience of reality in your listening room - - - the experience of listening to an almost perfect sound image. From many man years of research, McIntosh promises you nearly perfect sound images will occur in your listening room - - - whatever the room is like! (See page 18 for the McIntosh Environmental Equalizers.) They give you the

flexibility to properly match McIntosh loudspeakers to *your* room. For the first time loudspeakers and electronics have been designed *together* to give you near perfection in reproduction in your listening room. To say it differently - - - if the actual live or real sound would please you in your listening room then the McIntosh loudspeaker in your listening room will equally please you.

THE MCINTOSH PROMISE OF RELIABILITY

You have just read the McIntosh Promise of Performance. Now - - - read the McIntosh Promise of Reliability: each mechanism and each crossover component is protected by the *McIntosh 5 Year Service Contract* - - - free.



McINTOSH is THE SOUND OF REALITY

HERE'S BEAUTIFUL

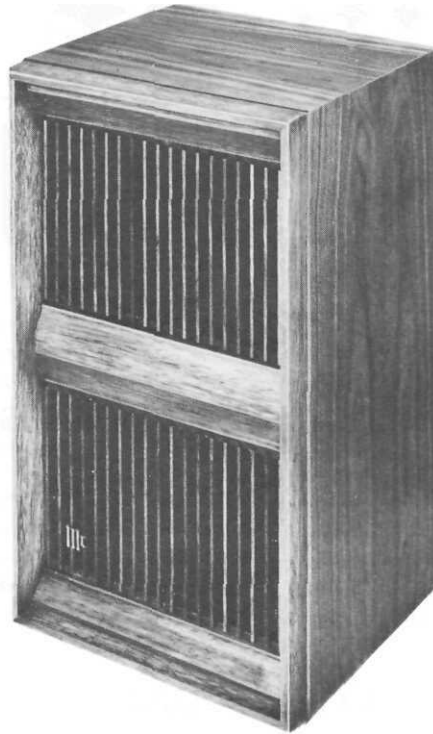
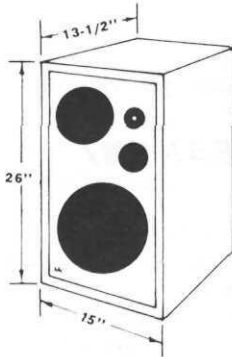

ML 1C

- 1 - 10" (25.4cm) Radiator - 12" (30.48cm) Loudspeaker
- 1 - 5" (12.7 cm) Radiator - 8" (20.32 cm) Loudspeaker
- 11-1/2" (3.81 cm) Dome Radiator
- 1 - Coaxial Super Radiator

Cabinet is particleboard construction using genuine walnut veneers. Front panel has a matching walnut finish on selected hardwood solids. Decorative grilles have a simulated walnut finish on the front surface of polystyrene moldings.



ML2C

- 2 - 10" (25.4cm) Radiator - 12" (30-48 cm) - Loudspeakers
- 1 - 5" (12.7 cm) Radiator - 8" (20.32cm) Loudspeaker
- 2 - 1-1/2" (3.81 cm) Dome Radiators
- 1 - Coaxial Super Radiator

Cabinet is particleboard construction using genuine walnut veneers and selected hardwood solids. Front panels have a matching walnut finish on selected hardwood solids. Decorative grilles have a simulated walnut finish on the front surface of polystyrene moldings.

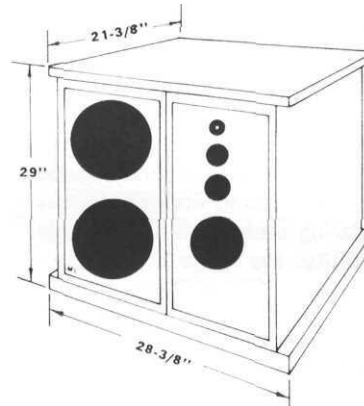

ML2M

- 2 - 10" (25.4 cm) Radiator - 12" (30.48 cm) Loudspeakers
- 1 - 5" (12.7cm) Radiator-8" (20.32cm) Loudspeaker
- 2 - 1-1/2" (3.81 cm) Dome Radiators
- 1 - Coaxial Super Radiator

Cabinet is particleboard construction using genuine pecan veneers and selected hardwood solids. Front panels have a matching pecan finish on a rigid polyurethane molding.

IN YOUR LISTENING ROOM

FURNITURE TO MAKE THE WHOLE FAMILY PROUD

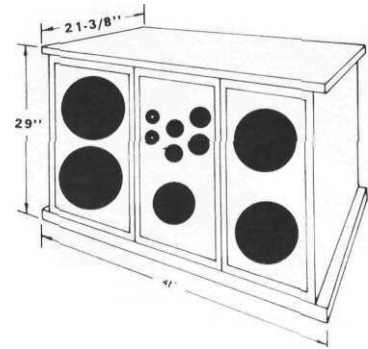

- ML 4C**
4 - 10" (25.4cm) Radiator - 12" (30.48cm) Loudspeakers
1 - 5" (12.7cm) Radiator - 8" (20.32cm) Loudspeaker
4 - 1-1/2" (3.81 cm) Dome Radiators
2 - Coaxial Super Radiators

Cabinet is particleboard construction using genuine walnut veneers and selected hardwood solids. Front panels have a matching walnut finish on selected hardwood solids. Decorative grilles have a simulated walnut finish on the front surface of polystyrene moldings.

MCINTOSH ML 10C LOUDSPEAKER

The McIntosh ML 10C is a new addition to the McIntosh Loudspeaker family. It is a speaker system using the design techniques used in previous McIntosh loudspeaker systems. The performance achievement is without peer for a loudspeaker of this size and price. Wide dispersion, exceedingly low intermodulation and harmonic distortion, uniform frequency response, and ample power handling capacity are features of the ML 10C

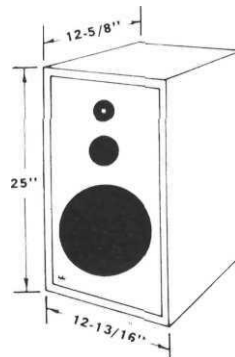

- ML 10C**
1 - 8-3/8" (21.27 cm) Radiator - 10" (25.4 cm) Loudspeaker
1 - 1-1/2" (3.81 cm) Dome Radiator
1 - Coaxial Super Radiator

Cabinet is particleboard construction using genuine walnut veneers. Front panel has a matching walnut finish on selected hardwood solids. Decorative grilles have a simulated walnut finish on the front surface of polystyrene moldings.

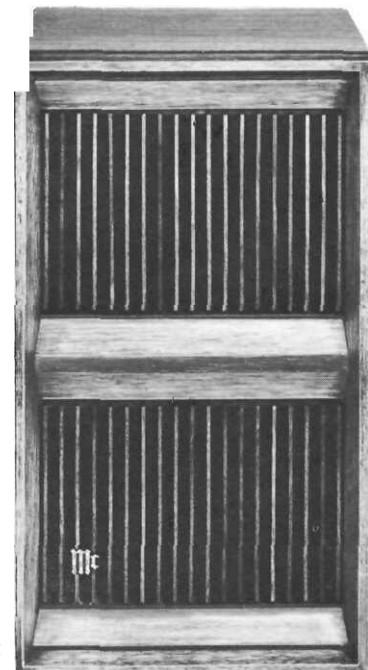

With Your McIntosh Loudspeakers Use The....

McINTOSH ENVIRONMENTAL EQUALIZER FOR THE SOUND OF REALITY IN YOUR LISTENING ROOM



MQ 101 — Shown in walnut veneer cabinet

In McIntosh loudspeakers, the characteristics of the speaker enclosure (cabinet) and of the loudspeaker have been combined to produce near perfect transient response. The design for excellent transient response must compromise the system's

low frequency response. The most effective way of restoring flat low frequency response is the use of an electrically equalized speaker input signal. McIntosh Environmental Equalizers do that job.

A switch selects from the five different high frequency equalization curves. High frequency control permits the tailoring of the response of the entire system to compensate for room characteristics such as large areas of glass and large areas of plaster.

A switch selects from five different mid-frequency equalization curves. Mid-frequency control permits the tailoring of the response of the entire system to compensate for room furnishings and room acoustics.

The MQ 101 McIntosh Environmental Equalizer is a three band equalizer divided into low frequencies, mid-frequencies and high-frequencies.

A concentric switch selects from five different low frequency equalization curves independently in each channel. In addition to restoring flat response the low frequency equalization is used to compensate for the placement of loudspeakers in the listening room.

SIZE; Front panel: 16 inches wide (40.64 cm) by 2-15/16 inches high (7.46 cm). Chassis: 15 inches wide (38.1 cm) by 13 inches deep (33.02 cm) including PANLOC shelf and back panel connectors; Knob Clearance: 1-1/2 inches (3.81 cm) in front of mounting panel.

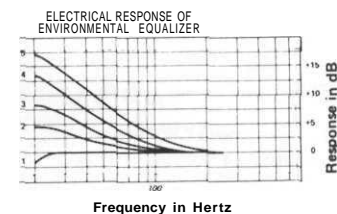
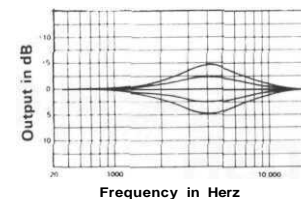
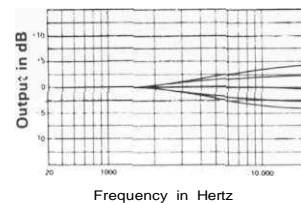

MQ102

The McIntosh MQ 102 is a single band equalizer that compensates below 150 Hz. The performance and operation are identical to the MQ 101 low frequency compensation abilities.

SIZE: Chassis measures 6-3/4 inches wide (17.15 cm) by 2-1/2 inches high (6.35 cm) by 4-1/8 inches deep (10.48 cm). Knob clearance required is 1-1/2 inches (3.81 cm).

Conventionally designed loudspeakers should not be used with a McIntosh Environmental Equalizer since it will overdrive them. The result will be increased distortion and decreased life expectancy of the speaker. Conversely, McIntosh loudspeakers should not be used without the McIntosh equalizers. They are designed to produce the low intermodulation characteristics and proper frequency balance which is so important to McIntosh sound—the SOUND of REALITY.



Shown in walnut veneer cabinet

**Performance - flexibility - long
trouble free life - describe the**

C-26 PREAMPLIFIER

Performance Limits

BASS:

Separate 11 position rotary switches for each channel.
20 dB to +16 dB at 20 Hz.

TREBLE:

Separate 11 position rotary switches for each channel.
-20 dB to +20 dB at 20,000 Hz.

LOUDNESS:

Flat response, or continuously variable loudness equalization as volume level is reduced.

TAPE MONITOR:

Two pushbutton switches. Either of two tape recorders can be monitored by selecting the TAPE 1 pushbutton or TAPE 2 pushbutton. They are mechanically interlocked to accept only one pushbutton at the IN position at one time.

LF FILTER (Rumble Filter):

Flat or roll-off 6 dB per octave below 50 Hz, down 12 dB at 20 Hz.

HF FILTER (Scratch Filter):

Flat or roll-off 6 dB per octave above 6,000 Hz, down 12 dB at 20,000 Hz.

SPEAKER:

Main - Switch the MAIN loudspeaker system ON or OFF without affecting the performance of REMOTE speakers.
Remote - Switch the REMOTE loudspeaker system ON or OFF without affecting the performance of MAIN speakers.

HEADPHONE JACK:

For listening with low impedance dynamic stereo headphones. Power to this jack is supplied when the output of the amplifier is properly connected to the C 26.

CENTER CHANNEL LEVEL:

Top of chassis control to adjust the output level of the left plus right program material at the CENTER CHANNEL output on the back panel.

PHASE CONTROL:

Electronically reverse phase in the left channel to correct "out of phase" program sources.

FREQUENCY RESPONSE: +0, -0.5 dB 20 Hz to 20,000 Hz.

DISTORTION: Will not exceed 0.1% at any level up to 2.5 volts output, 20 Hz to 20,000 Hz.

INPUT SENSITIVITY AND IMPEDANCE:

Auxiliary, Tuner, Tape 1, Tape 2, 0.25 volts at 250,000 ohms. Phono 1 and Phono 2, 2 millivolts at 47,000 ohms (1,000 Hz).

HUM AND NOISE:

Auxiliary, Tuner, Tape 1, and Tape 2, 85 dB below rated output. Phono 1, Phono 2, 74 dB below 10 millivolts input, equivalent to less than 2 microvolts at the input terminals.

OUTPUT LEVEL AND IMPEDANCE:

Main Output: 2.5 volts with rated input, 200 ohms source impedance, to operate into 47,000 ohms or more. Tape Output: 0.25 volts, 200 ohms source impedance, from low level inputs to operate into 47,000 ohms or more. Center Channel Output: (L + R) 2.5 volts with rated input to both channels, 1,200 ohms source impedance, to operate into 47,000 ohms or more. A level control adjusts the center channel output from +6 dB with respect to Main output.

AMPLIFICATION IN DECIBELS:

Auxiliary, Tuner, Tape 1 and Tape 2 to Main Output 20 dB; to Tape Output 0 dB; Phono 1 and Phono 2 (at 1,000 Hz); to Main Output 62 dB; to Tape Output 42 dB.

SEMICONDUCTOR:

18 silicon planar transistors, and 3 silicon diodes.

POWER REQUIREMENT:

120 volts, 50/60 Hz, 15 watts.

MECHANICAL

SIZE: Front panel: 16 inches wide (40.64 cm) by 5-7/16 inches high (13.81 cm). Chassis: 15 inches wide (38.1 cm) by 5 inches high (12.7 cm) by 13 inches deep (33.02 cm) including PANLOC mounting brackets and back panel connectors. Knob clearance required as 1-1/2 inches (3.81 cm) in front of the mounting panel.

FINISH: Front panel is anodized gold and black with special McIntosh gold/teal panel nomenclature illumination.

CHASSIS: black.

MOUNTING: McIntosh developed professional PANLOC.

WEIGHT: 18 pounds (8.16 kg) net, 33 pounds (14.97 kg) in shipping carton.

THE McIntOSH C28 STEREO PREAMPLIF EASIEST TO USE- - MOST ADVANCED



Shown in walnut veneer cabinet

McIntosh engineers could not be content with just another preamplifier. New concepts and new technology have produced a preamplifier that gives you the greatest flexibility ever. Look at the great number of ways you can enjoy the C 28.

- Use 3 tape machines
2 with their own electronics and 1 tape playback deck with complete easy front panel switching

Built-in Headphone Amplifier
listen to your favorite music - - - privately

- Main and Remote Loudspeaker Switching
turn the main speakers on or off without affecting the remote speakers and vice versa (operates with accessory relay).
- New Low Noise Phono Input
listen to your records with a new quietness
- Individual Channel Phono Level Controls
match levels from different phono cartridges without degrading signal to noise ratio
- Individual Channel Output Level Controls
perfect balance from your stereo always
- Individual Channel Tone Control Switches
complete, repeatable flexibility
- NEW Compensation Control
one position for loudness compensation, one position is flat and (NEW) a third position that adds presence compensation!

NEW LOW NOISE PHONO CIRCUITS

New records and tapes with greatly increased dynamic range demanded new low noise circuits. McIntosh scientists developed a new DIFFERENTIAL INPUT CIRCUIT that reduced phono input noise levels from approximately 2.4 microvolts in an excellent preamplifier to a new level of only 1.2 microvolts! The differential input circuit has only been used in very sensitive professional test equipment and in medico-electronics. The preamplifier will not overload or change distortion for any phono input signal from 2 millivolts up to 500 millivolts. This represents a dynamic range of approximately 3000 to 1 on a voltage basis. This fantastic improvement necessitated extreme care in layout and manufacturing. The signal circuits need careful shielding and wiring with coaxial cable to prevent noise and crosstalk in the preamplifier from destroying the low noise of the input circuit.

NEW TAPE FLEXIBILITY

With the C 28 you can copy from one tape recorder to another while listening to a completely different program! In addition, you can monitor the recording by simply pushing a button and an input circuit has been provided to accept the signal from a tape playback deck.

You can use three tape machines with the C 28. There are front panel jacks that permit the use of the third tape recorder. When plugged into the front panel jacks the tape recorder connected to Tape Recorder 2 is **automatically** disconnected and the controls provided are used with the third tape recorder.

NEW HEADPHONE AMPLIFIER

Use your headphones for private listening. Ample power has been provided to power today's high quality low impedance dynamic headphones, plus a separate power switch in the preamplifier turns the power amplifiers on or off. It is not necessary to operate the power amplifiers while listening to headphones.

IER IS THE QUIETEST--MOST FLEXIBLE-- AND HAS THE LOWEST DISTORTION!

Performance Limits

FREQUENCY RESPONSE:

+0-0.5 dB 20 Hz to 20,000 Hz

DISTORTION:

Will not exceed 0.1% at rated output level, 20 Hz to 20,000 Hz.

INPUT SENSITIVITY AND IMPEDANCE:

Auxiliary, Tuner, Tape 1, Tape 2, 0.25 volts; 250,000 ohms. Phono 1 and Phono 2, 2 millivolts; 47,000 ohms (1,000 Hz). Microphone, 2.5 millivolts; 500,000 ohms. Tape Head, 2 millivolts; 500,000 ohms (500 Hz).

HUM AND NOISE:

Auxiliary, Tuner, Tape 1, Tape 2: 90 dB below rated output. Phono 1, Phono 2 and Tape Head: 78 dB below 10 millivolts input, equivalent to less than 1.2 microvolts at the input terminals. Microphone: equivalent to less than 1.5 microvolts at the input terminals.

OUTPUT LEVEL AND IMPEDANCE:

Main Output: 2.5 volts with rated input, 100 ohms source impedance, to operate into 47,000 ohms or more. Tape Output: 0.25 volts, 150 ohms source impedance, from low level inputs, to operate into 47,000 ohms or more. Headphone/Line Output: 0.75 volts into 8 ohm load or 2.5 volts into 600 ohm line, 0.2 ohm source impedance. Center Channel Output: 1.25 volts with rated input to both channels, to operate into 47,000 ohms or greater.

AMPLIFICATION IN DECIBELS:

Auxiliary, Tuner, Tape 1 and 2 to Main Output: 20 dB; to Tape Output: 0 dB; to Headphone/Line Output: 17.5 dB. Phono 1 and Phono 2 at 1,000 Hz to Main Output: 62 dB; to Tape Output: 42 dB; to Headphone/Line Output: 59.5 dB. Microphone: to Main Output: 60dB; to Tape Output: 40 dB; to Headphone/Line Output: 57.5 dB. Tape Head at 500 Hz: to Main Output: 64 dB; to Tape Output: 44 dB; to Headphone/Line Output: 61.5 dB.

POWER REQUIREMENT:

120 volts, 50/60 Hz, 45 watts.

FACILITIES AND FEATURES

BASS CONTROLS:

11 position rotary switch in each channel, \pm 20 dB at 20 Hz.

TREBLE CONTROLS:

11 position rotary switch in each channel, \pm 18 dB at 20,000 Hz.

COMPENSATION SWITCH:

Three position switch for Flat, Loudness, or Presence. Loudness position boosts low frequencies for low level listening. Presence position boosts mid frequencies 4 dB to increase "presence" effect.

VOLUME CONTROL:

AC power ON/OFF switch is coupled with this control.

MODE SELECTOR:

Seven positions: Left channel only to both speakers, Right channel only to both speakers. Stereo Reverse, Stereo, Mono, L + R to left speaker only, and L + R to right speaker only.

TAPE MONITOR SWITCHES:

Either of two tape recorders can be monitored by use of either the TAPE 1 or TAPE 2 pushbutton.

TAPE COPY SWITCH:

Provides switching to copy from tape machine 1 to tape machine 2 or vice versa without affecting the program being heard.

LF FILTER SWITCH (Rumble Filter):

Flat or roll-off at 12 dB per octave below 50 Hz, down 18 dB at 20 Hz.

HF FILTER SWITCH (Scratch Filter):

Flat or roll-off at 12 dB per octave above 7,000 Hz, down 18 dB at 20,000 Hz.

SPEAKER SWITCHES (Operates with accessory relay):

Turn the main speakers on or off without affecting the remote speakers and vice versa.

HEADPHONE JACK:

Power to this jack is supplied by an amplifier provided in the C 28.

LOW FREQUENCY TRIM CONTROLS:

Use to compensate for unequal speaker response or the unequal influence of room acoustics.

PHONO 1 AND PHONO 2 LEVEL CONTROLS:

Provides for optimum signal to noise ratio and proper balance of the channels of the phono cartridge.

OUTPUT LEVEL CONTROLS:

Permits presetting the balance of the entire system.

HEADPHONE LEVEL CONTROLS:

Adjusts the output of the headphone/line amplifier output.

TRANSISTOR COMPLEMENT:

26 silicon-planar transistors, 4 silicon diodes, 2 silicon bridge rectifiers.

MECHANICAL

SIZE:

Front panel measures 16 inches wide (40.64 cm) by 5-7/16 inches high (13.81 cm). Chassis measures 15 inches wide (38.1 cm) by 5 inches high (12.7 cm) by 13 inches deep (33.02 cm) including PANLOC mounting brackets and back panel connectors. Knob clearance required is 1-1/2 inches (3.81 cm) in front of the mounting panel.

FINISH:

Front panel is anodized gold and black with special gold/teal nomenclature illumination. Chassis is black.

MOUNTING:

Exclusive McIntosh developed professional PANLOC.

WEIGHT:

25 pounds (11.34 kg) net, 37 pounds (16.78 kg) in shipping carton.

Speaker Control Relay

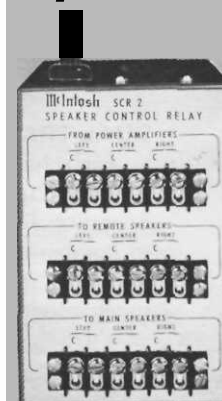

SCR 2

The McIntosh Speaker Control Relay is designed for use with the McIntosh C 28 Stereo Preamplifier. The SCR 2 provides for remote control of both the AC power to the remote amplifier and the on/off control of the Main and Remote loudspeakers. Control for the SCR 2 is provided by pushbuttons and a low voltage supply in the C 28.

SIZE: Chassis measures 6-3/4 inches wide (17.15 cm) by 2-1/2 inches high (6.35cm) by 4-1/8 inches deep (10.48cm). Terminal clearance required is 1-1/2 inches (3.81 cm)

THE MCINTOSH MPI4 MAXIMU

The MPI 4 helps you get

- *max/mum performance from your stereo system*
- *a v/ew of the separation provided on any signal source*
- *absolute balance of your stereo channels from phono cart*

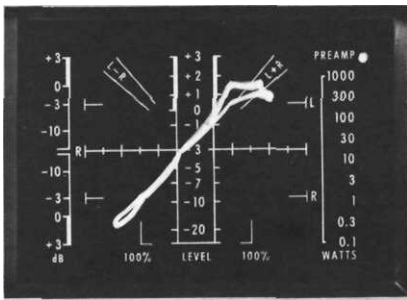

PHONOCARTRIDGE CALIBRATION

You will protect your record investment, extend the life of your records, and reduce needle wear when the turntable is properly set up. With the aid of test recordings the MPI 4 will assist in this proper set up. The display assists in properly adjusting for proper tracking force, best tracing vs tracking force, anti-skate, proper phasing, and channel separation.

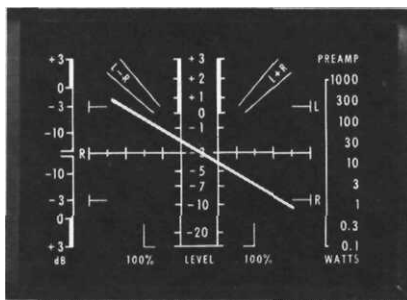
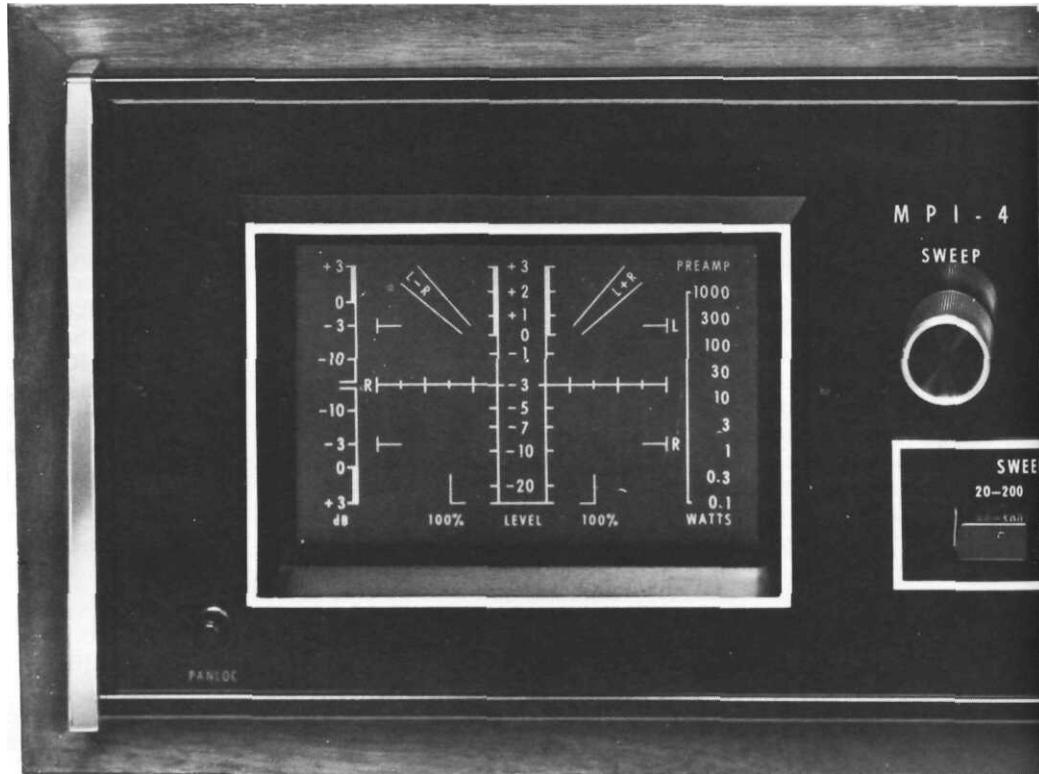

PHASE

Program material that is "out of phase" sounds unnatural and thin; "in phase" sounds alive and rich. Occasionally a program source will be "out of phase." On the MPI 4 you can see the phase relationship so you can correct the condition.

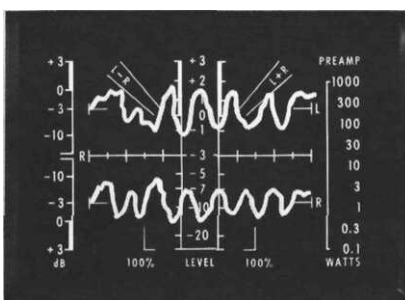

DUAL TRACE

Each channel of stereo signal is displayed individually in the dual trace mode of operation. Comparison of the signals assists in comparison of recordings, the quality of stereo information in the source and much other valuable information.

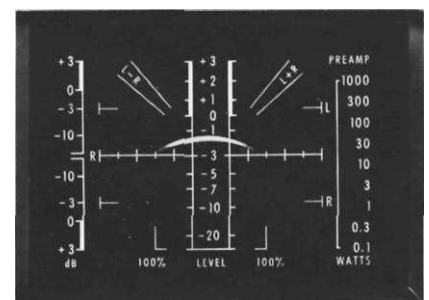

FM TUNING

You'll see signal strength, center channel FM tuning and a reference for multipath distortion elimination. The image is a display of the tuner IF curve. Signal strength is the vertical axis. Horizontal center is the center of the detector and IF curves. Proper tuning gives minimum distortion and maximum listening pleasure on all kinds of FM broadcasts.

M PERFORMANCE INDICATOR

- *better FM reception*
- *"once in a lifetime" programs flawlessly recorded*
- *a measurement of the performance of the phono cartridge*
- *accurate measurement of power output*

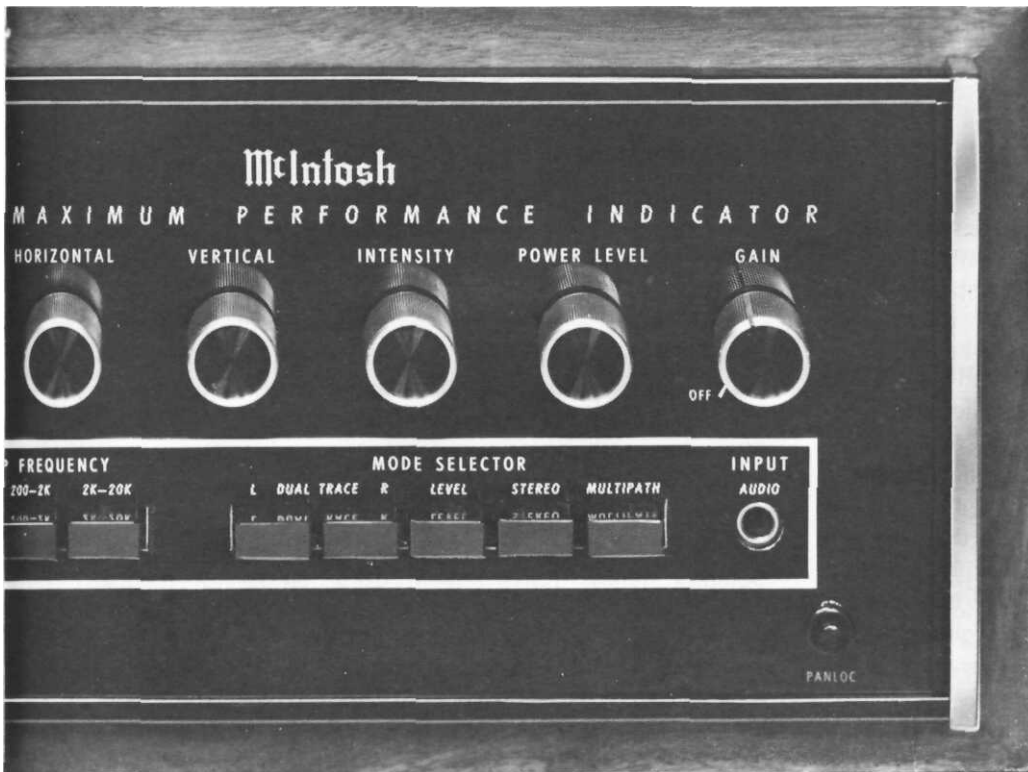

Shown in walnut veneer cabinet

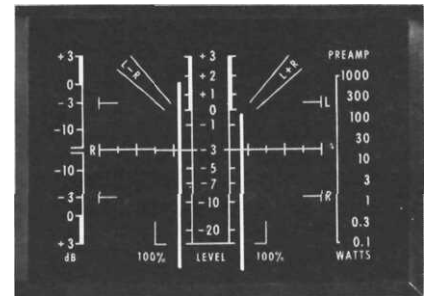

LEVEL

The audio level of stereo signals is displayed as two vertical columns on the screen. The height of each column is determined by the power or amplitude of the input signal.

Action can be stopped and held to permit close comparison between the highest levels attained by left and right channels.

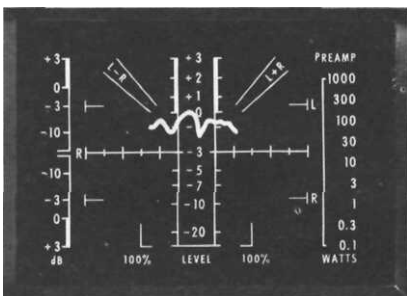

MULTIPATH DISPLAY

Multipath reception deprives you of FM listening enjoyment in several ways:

- noise level increase
- distortion is introduced into the program material
- stereo separation is reduced
- the stereo effect may be completely lost
- stereo indicators may fail to function

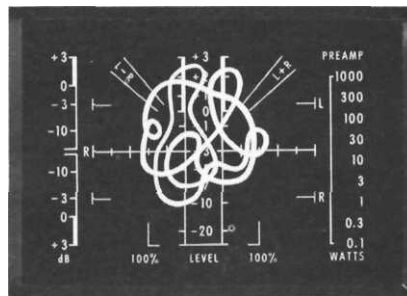

CHANNEL SEPARATION

The MPI 4 shows the stereo separation from all stereo program material. The display changes position and shape with the program material to permit interpretation of what the display means to your listening enjoyment. You see what makes a good stereo record sound good. You will know why your records sound the way they do.

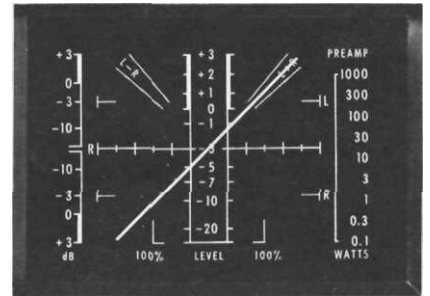

BALANCE

Accurate system balance assures you of full stereo pleasure. The MPI 4 gives you a visual indication of the balance of your stereo system. You can check and correct the output balance of your stereo phono cartridge, tape recorder, tuner, or any part of your stereo system. You will know when your stereo system is in balance when you use an MPI 4.

THOROUGH, UNINHIBITED RESEARCH HAS DEVELOPED THE NEW TECHNOLOGY NECESSARY FOR A TRULY LOW DISTORTION FM TUNER WITH VARIABLE SELECTIVITY.....

THE McINTOSH MR 78!

McIntosh research is a continuous program of exploration for new technology that permits performance improvement and greater value for you. This unrestricted research program developed the new technology necessary for the realization of these new design concepts for the MR 78.

THE DISTORTIONLESS IF FILTER

Ever since the beginning of FM, research engineers have realized that constant delay IF filters (equivalent to linear-phase) were necessary for low distortion reception. Crude approximations to constant delay have always been used in FM tuners - with disappointing results. So-called "Butterworth" or "Legandre" filters offer only a fair compromise with respect to delay error. Crystal and ceramic filters, usually based on the "Chebychev" model, work fairly well and give good selectivity, but none of these are constant delay (linear-phase) filters. Commercial tuners using these filters can show 5% stereo IM distortion at 100% modulation. The filters used in today's tuners can have delay errors up to 100%! The IF filter in the MR 78 has a delay error of less than 1% from antenna input to discriminator output! In its useful bandpass, it is a true mathematical approximation to linear-phase - the world's finest selective, linear-phase, minimum-phase shift filter.

A FORTRAN computer program using an algorithm that took six years to develop was used in its design. The mathematical complexity of the filter design procedure is almost beyond belief. Using a process called "numerical integration in the complex S-plane," a high speed IBM 1130 computer spent eighteen minutes on the design of the IF filter. A human engineer, working twenty-four hours a day and seven days a week, would have taken 300 years to finish this work . . . assuming he made no mistakes!

LINEAR PHASE BRIDGE DISCRIMINATOR

The excellence of the IF filter would be useless if it had to work into an ordinary FM detector. Thus a new detector with suitably low distortion had to be developed. A search of the available literature revealed a little-known bridge circuit with a theoretical distortion of zero! However, designing a practical working circuit for a commercially feasible stereo tuner took some doing. A U. S. patent is pending on this circuit.

Distortion performance of the bridge detector is pretty close to the theoretical zero. In addition to its excellent distortion performance, the bridge detector also exhibits capture ratio close to 0 dB.

Tuned circuits are not used in the MR 78 detector. They are quite difficult to manufacture and align accurately, and ordinary tuned-circuit discriminators go out of adjustment. There has been much talk about "permanently aligned" IF filters, but much silence concerning the most important source of misalignment in these same tuners - the discriminator. The two simple variable resistor adjustments in the MR 78 detector merely center the tuning meter and set the transistor bias. Complex tuning for minimum distortion is not needed.

NEW VARIABLE SELECTIVITY

The MR 78 has excellent selectivity. The bandwidth (210 kHz wide at 60 dB down) permits tuning stations that are impossible on ordinary tuners. Even though the MR 78 has the narrowest IF bandwidth ever used in a stereo tuner, (it is the correct width to let just one FM station through) the great number of stations crowding the FM band requires a tuner with variable selectivity.

Variable selectivity allows stereo reception even under severe receiving conditions. In the NORMAL position, a very low distortion 8-pole filter is used in the IF circuit for listening to local broadcasts.

The NARROW position adds a sharp 8-pole filter to the NORMAL IF filter to yield a low distortion (less than 0.2%), highly selective 16-pole composite IF filter. In the NARROW position interference is reduced while receiving distant stations.

SUPER-NARROW position adds a 4-pole 4-zero crystal filter to the two other IF filters. SUPER NARROW permits receiving distant stations which are on channels adjacent to local stations. With an adequate FM antenna there are usable signals never heard before with ordinary FM tuners.

Beautiful styling, extended control flexibility and meaningful illuminated operational indicators bring the McIntosh MR 78 to a new high level of professionalism.

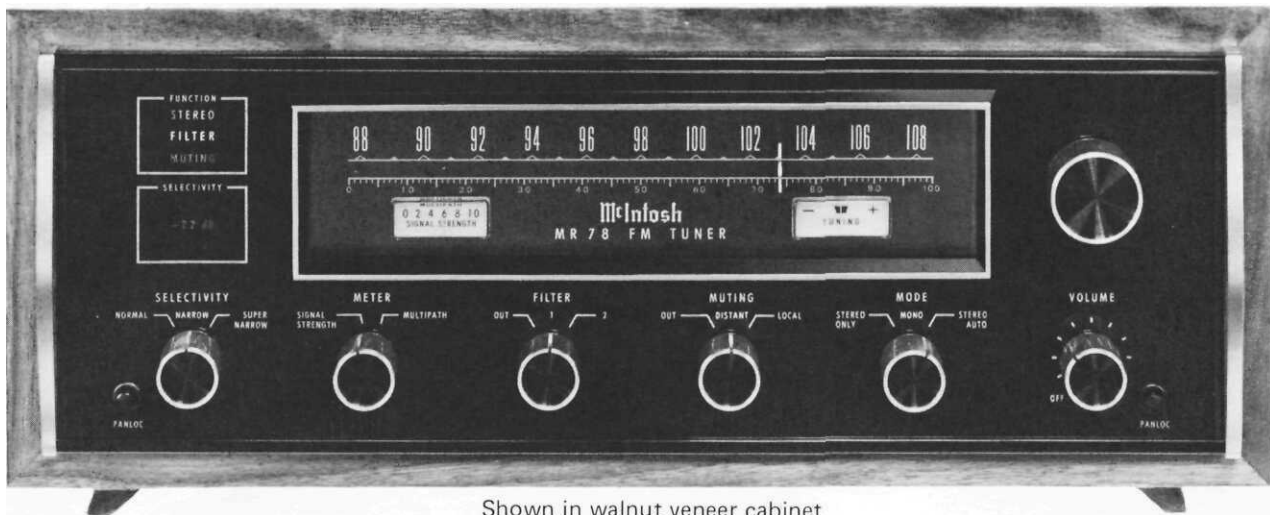

Shown in walnut veneer cabinet

PERFORMANCE GUARANTEE:

Performance limits are the maximum deviation from perfection permitted for a McIntosh instrument. We promise you that the MR 78 you buy must be capable of performance at or exceeding these limits or you get your money back. McIntosh is the only manufacturer that makes this guarantee.

Performance Limits

TUNING RANGE:

88 to 108 MHz.

ANTENNA INPUTS:

300 ohms balanced; 75 ohms unbalanced.

INTERMEDIATE FREQUENCY:

10.7 MHz.

SENSITIVITY:

2 mV for 35 dB quieting; 2.5 mV at 100% modulation (\pm 75 kHz deviation) for 3% total noise and harmonic distortion.

SIGNAL TO NOISE RATIO:

75 dB below 100% modulation.

HARMONIC DISTORTION:

0.2% mono or stereo at 100% modulation, 20 Hz to 15,000 Hz. Typically, 0.05% at 1,000 Hz.

DRIFT:

25,000 Hz for the first two minutes; thereafter 5,000 Hz at 25° C in 24 hours.

FREQUENCY RESPONSE:

Mono: \pm 1 dB 20 Hz to 20,000 Hz with standard de-emphasis, (75 mS); Stereo: \pm 1 dB 20 Hz to 15,000 Hz with standard de-emphasis (75 mS).

CAPTURE RATIO:

0.25 dB detector only; 2.5 dB complete tuner.

SELECTIVITY: Switch Setting:

	NORMAL	NARROW	SUPER NARROW
Adjacent Channel	7 dB	22 dB	55 dB
Alternate Channel	55 dB	> 90 dB	>> 90 dB

SPURIOUS REJECTION:

100dB IHF.

IMAGE REJECTION:

100 dB at 88 to 108 MHz (IHF).

INTERMODULATION DISTORTION:

0.2% mono or stereo for any combination of frequencies from 20 Hz to 15,000 Hz with peak modulation equal to 100% or less. Typically 0.1%.

MAXIMUM SIGNAL INPUT:

12 volts across 300 ohm antenna terminals will not increase harmonic or intermodulation distortion.

AUDIO HUM:

75 dB down from 100% modulation.

MUTING:

70 dB noise reduction between stations.

MUTING THRESHOLD (Typical):

DISTANT position 5 mV; LOCAL position 20 mV

SCA FILTER:

50 dB down from 67 kHz to 74 kHz; 275 dB per octave slope.

STEREO SEPARATION:

40 dB at 1,000 Hz.

STEREO FILTER (Typical):

10 dB noise reduction in Position 1.

20 dB noise reduction in Position 2.

AUDIO OUTPUT:

Front Panel Controlled: 2.5 volts into 47,000 ohms; Fixed Output: 2.5 volts into 47,000 ohms, 1.0 volts into 600 ohms. All tuner performance limits were measured with SELECTIVITY switch set at NORMAL, unless otherwise stated.

GENERAL

POWER REQUIREMENT:

120 volts, 50/60 Hz 35 watts.

SEMICONDUCTOR COMPLEMENT:

3 JFET's, 2 MOSFET's, 17 Bipolar Transistors, 43 Diodes, 4 Integrated Circuits.

MECHANICAL

SIZE:

Front panel: 16 inches wide (40.64 cm) by 5-7/16 inches high (13.81 cm); Chassis: 15 inches wide (38.1 cm) by 13 inches deep (33.02 cm), including PANLOC shelf and back panel connectors; Knob Clearance: 1-1/2 inches (3.81 cm) in front of mounting panel.

FINISH:

Front panel: Anodized gold and black with special gold/teal panel nomenclature illumination; Chassis: Chrome and black.

MOUNTING:

McIntosh developed professional PANLOC.

WEIGHT:

27 pounds (12.25 kg) net, 39 pounds (17.69 kg) in shipping carton.

LOW DISTORTION AND HIGH PERFORMANCE FOR SUPERIOR FM THE MR 77

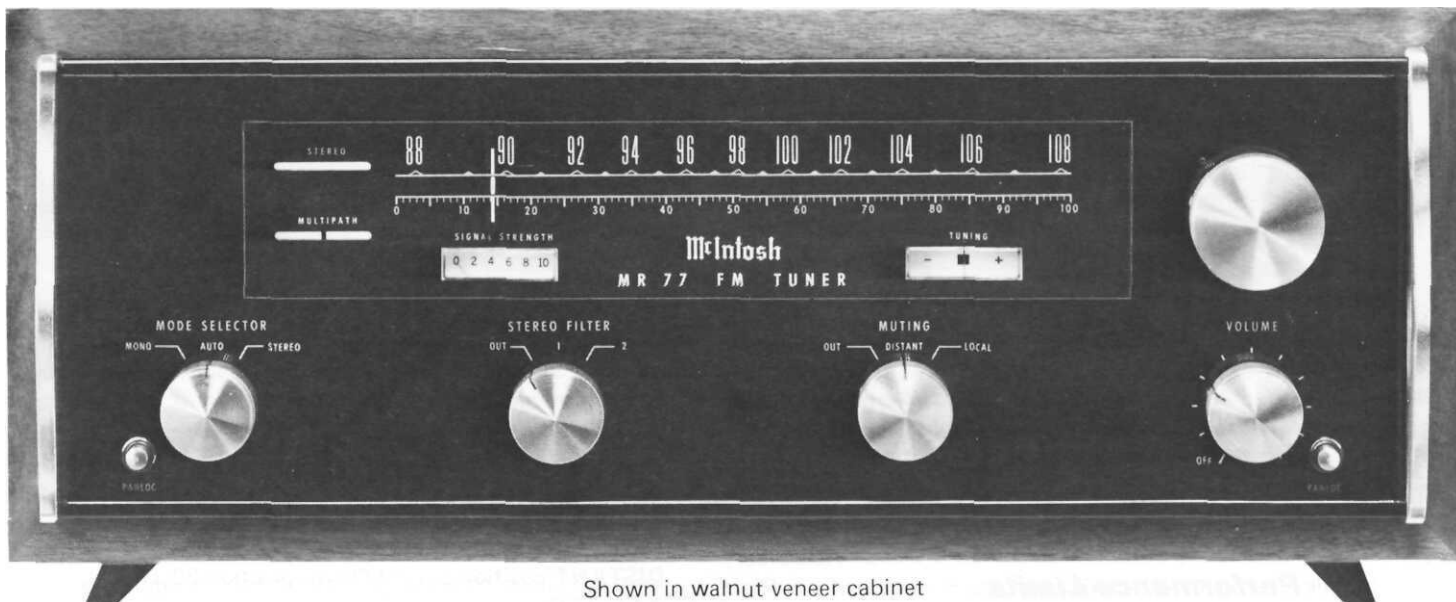

Shown in walnut veneer cabinet
Performance Limits

USABLE SENSITIVITY:

2 mV for 35 dB of quieting, 2.5 microvolts typical.

SIGNAL TO NOISE RATIO:

75 dB below 100% modulation

HARMONIC DISTORTION:

Will not exceed 0.2% mono or stereo at 100% modulation, 20 Hz to 15,000 Hz.

INTERMODULATION DISTORTION:

Will not exceed 0.2% mono or stereo for any combination of frequencies from 20 Hz to 15,000 Hz with peak modulation equal to 100% or less, 0.1% typical.

AUDIO FREQUENCY RESPONSE:

± 1 dB 20 Hz to 15,000 Hz with standard de-emphasis, (75 ms) and 19,000 Hz pilot filter.

CAPTURE RATIO:

0.25 dB detector only; 2.5 dB complete tuner at 100% modulation.

SPURIOUS REJECTION:

100 dB.

IMAGE REJECTION:

100 dB at 88 to 108 MHz (1HF).

SELECTIVITY:

Adjacent channel: 6 dB; Alternate channel: 50 dB.

STEREO SEPARATION:

40 dB at 1,000 Hz.

STEREO FILTER:

10 dB noise reduction in position 1; 20 dB noise reduction in position 2.

SCA FILTER:

50 dB down from 67 kHz to 74 kHz; 275 dB per octave slope.

DRIFT:

25,000 Hz in first two minutes; thereafter 5,000 Hz in normal temperatures.

MUTING:

70 dB noise reduction between stations.

MUTING THRESHOLD:

Position 1, 5 mV. Position 2, 20 mV.

ANTENNA INPUTS:

300 ohms balanced; 75 ohms unbalanced.

MAXIMUM SIGNAL INPUT:

12 volts across 300 ohms antenna terminals will not increase harmonic or intermodulation distortion.

AUDIO OUTPUT:

2.5 volts into 47,000 ohms; 1 volt into 600 ohms from fixed output.

IF SYSTEM:

8-Pole IF filter,
2 IC's

1 J-FET, and push-pull overlay power transistor stage driving a linear phase bridge discriminator.

STEREO INDICATOR:

Stereo light activated by 19,000 Hz only.

AUTOMATIC MONO-STEREO SWITCH:

McIntosh developed; all electronic automatic mono-stereo switching circuit.

GENERAL

SEMICONDUCTOR COMPLEMENT:

21 Transistors
4 Integrated Circuits
1 Indicator Tube.

POWER REQUIREMENT:

120 volts, 50/60 Hz, 35 watts.

MECHANICAL

SIZE

Front panel: 16 inches wide (40.64 cm) by 5-7/16 inches high (13.81 cm); Chassis: 15 inches wide (38.1 cm) by 13 inches deep (33.02 cm) including PANLOC shelf and back panel connectors. Knob Clearance: 1-1/2 inches (3.81 cm) in front of mounting panel.

FINISH:

Front panel: Anodized gold and black with special gold/teal nomenclature illumination. Chassis: Chrome and black.

MOUNTING:

McIntosh developed professional PANLOC.

WEIGHT:

27 pounds (12.25 kg) net,
39 pounds (17.69 kg) in shipping carton.

NEW ENGINEERING NEW PERFORMANCE

THE MR 74 AM-FM/FM STEREO TUNER

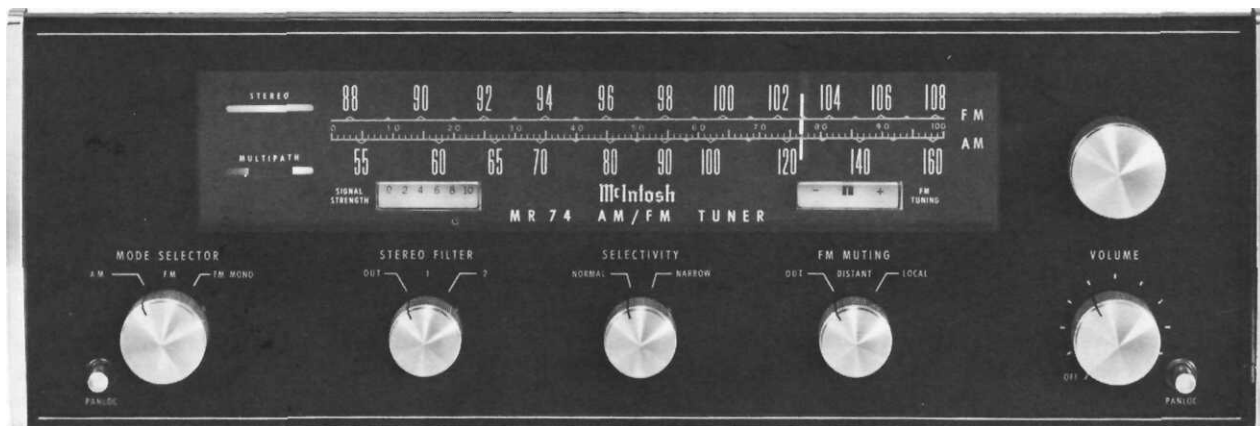

Shown in walnut veneer cabinet

A new addition to the front panel is the SELECT pushbutton. With it, control of the IF characteristics is brought to the front panel. It allows stereo reception even under severe receiving conditions. In the NORMAL position a very low distortion dual *QUAD-TUNED* IF filter is used. The dual *QUAD-TUNED* IF filter has unusual adjacent channel selectivity and low distortion. The *QUAD-TUNED* IF filter has equal time delay in its pass band region. All other IF filters have excessive delay distortion. The *QUAD-TUNED* IF filter has almost no delay distortion from antenna input to discriminator output! You get overall lower distortion performance.

Activating the SELECTivity pushbutton routes the signal to two double-tuned transformers, a ceramic filter network, and a single-gate MOS-FET. The sides of the IF curve are compressed by this circuit narrowing the IF bandpass. In this mode of operation weak stations adjacent to strong stations can be tuned with surprising clarity.

McIntosh has developed a special detecting circuit used in the multiplex section. A particular advantage of this circuit is the elimination of the critical adjustments necessary with commonly used matrixing circuits. The circuit detects the L - R sidebands, then

automatically matrixes the recovered information with the L + R carrier signal. This yields the left and right program output with maximum separation.

AM

For greater spurious rejection the AM-RF amplifier circuit includes a three section variable tuning capacitor in the metal enclosed shielded RF module which also houses the FM-RF front end. The AM circuit has constant sensitivity, constant selectivity, high image rejection across the complete AM band. This circuit design achieves equal sensitivity even down at the low end of the band. Spurious, image, and intermediate frequency rejection are all superior. The McIntosh circuit is unique in a superheterodyne AM receiver.

A high-quality loopstick antenna is provided. It can be rotated for maximum performance, optimum signal rejection or minimum interference. Each loopstick is individually tuned for optimum performance. After tuning the loopstick is then sealed. Custom matching of the loopstick to the AM-RF front end maximizes the performance of the loopstick antenna.

Performance Limits

FM

SENSITIVITY: 2.5 mV at 100% modulation (± 75 kHz deviation) for 3% total noise and harmonic distortion

SIGNAL TO NOISE RATIO: 70 dB below 100% modulation

HARMONIC DISTORTION: MONO - 0.3% at 100% modulation ± 75 kHz deviation; STEREO - 0.5% at 100% modulation

DRIFT: 25,000 Hz for the first two minutes; thereafter 5,000 Hz at ambient temperatures

FREQUENCY RESPONSE: ± 1 dB 20 Hz to 15,000 Hz with standard de-emphasis (75 mS) and 19,000 Hz pilot filter

CAPTURE RATIO: 1.5 dB minimum

SELECTIVITY: Switch Setting: NORMAL NARROW

Adjacent Channel: 6 dB 15 dB

Alternate Channel: 58 dB 88 dB

SPURIOUS REJECTION: 90 dB

IMAGE REJECTION: 95 dB at 88 to 108 MHz (IHF)

MUTING: 50dB noise reduction in LOCAL position

SCA FILTER: 50 dB down from 67 kHz to 74 kHz; 275 dB per octave slope

STEREO SEPARATION: 35 dB at 1,000 Hz

STEREO FILTER: 10 dB noise reduction in Position 1; 20 dB noise reduction in Position 2

AM

SENSITIVITY: 75 mV (external ant.)

SIGNAL TO NOISE RATIO: 55 dB at 100% modulation; 45 dB minimum

HARMONIC DISTORTION: Does not exceed 1% at 30% modulation

SELECTIVITY: Switch Setting: NORMAL NARROW
Adjacent Channel: 35 dB 45 dB

IMAGE REJECTION: 65 dB minimum 540 kHz - 1600 kHz

FREQUENCY RESPONSE: 3500 Hz - 6 dB down, NORMAL position; 2100 Hz - 6 dB down, NARROW position. All tuner performance limits were measured with SELECTIVITY at NORMAL, unless otherwise stated.

GENERAL

POWER REQUIREMENTS: 120 volts, 50/60 Hz, 30 watts
SEMICONDUCTOR COMPLEMENT: 5 FETs, 17 transistors, 2 ICs, 28 diodes, 1 indicator tube

MECHANICAL

SIZE: Front panel: 16 inches wide (40.64 cm) by 5-7/16 inches high (13.81 cm); Chassis: 15 inches wide (38.1 cm) by 13 inches deep (33.02 cm), including PANLOC shelf and back panel connectors; Knob Clearance: 1-1/2 inches (3.81 cm) in front of mounting panel.

FINISH: Front panel: Anodized gold and black with special gold/teal panel nomenclature illumination; Chassis: Chrome and black.

MOUNTING: McIntosh developed professional PANLOC.

WEIGHT: 25 pounds (11.34 kg) net; 37 pounds (16.78 kg) in shipping carton.

HIGH PERFORMANCE, SOLID STATE ALL IN A COMPACT, BEAUTIFUL

MX 113 AM-FM/FM STEREO

OUTSTANDING NEW DESIGN AND PERFORMANCE

The IF in the FM consists of two integrated circuits and two *QUAD-TUNED* filters. They combine to give a total gain of over 120 dB (the signal is amplified to over 1,000,000 times its original level.) The IF filter has equal time delay in its pass band region. Any error in time delay causes FM distortion. All other IF filters have delay distortion, some as much as 100% of the 10.7 MHz transit delay. This circuit has less than 1.0% delay distortion from antenna input to discriminator output which makes possible the overall low distortion performance limit for the FM tuner and multiplex section.

The response curve of the IF has nearly linear phase characteristic. The skirts of the response curve are very steep. The maximum width is 170 kHz at -3.0 dB and 500 kHz at -60 dB. The response curve is symmetrical

each side of the center frequency. The filters are permanently sealed and do not require adjusting. The IF cannot drift nor vibrate out of adjustment. The exceptionally high gain of the two integrated circuits assures "hard limiting" at very low levels of input signals. Each integrated circuit contains 16 transistors, 3 zener diodes, 5 diodes and 23 resistors, all on a single monolithic silicon chip.

VARIABLE SELECTIVITY

A new addition to the front panel is the *SELECT* pushbutton. With it, control of the IF characteristics is brought to the front panel. It allows stereo reception even under severe receiving conditions. In the *NORMAL* position a very low distortion dual *QUAD-TUNED* IF filter is used. It exhibits unusual excellent adjacent channel selectivity and low distortion. The *QUAD-TUNED* IF filter has equal time delay in its pass band region. All other IF filters have excessive distortion.

The *QUAD-TUNED* IF filter has almost no delay distortion from antenna input to discriminator output! You get overall lower distortion performance.

Activating the *SELECTIVITY* pushbutton routes the signal to two double-tuned transformers, a ceramic filter network, a single-gate MOS-FET, and the dual *QUAD-TUNED* IF filters. The sides of the IF curve are compressed, narrowing the IF bandpass. In this mode weak stations adjacent to strong stations can be tuned with surprising clarity.

McIntosh has developed a special detecting circuit used in the multiplex section. A particular advantage of This circuit is the elimination of the critical adjustments necessary with commonly used matrixing circuits. The circuit detects the L — R sidebands, then automatically matrixes the recovered information with the L + R carrier signal. This yields the left and right program output with maximum separation.

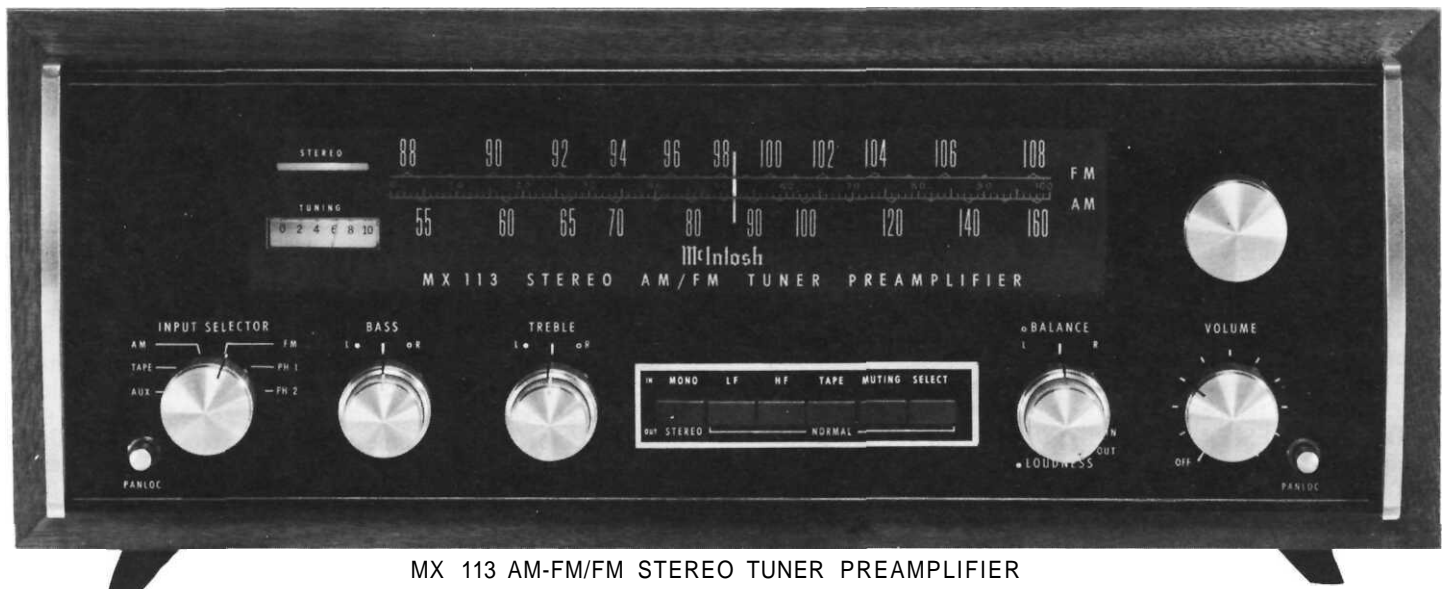

MX 113 AM-FM/FM STEREO TUNER PREAMPLIFIER

Shown in walnut veneer cabinet

AM-FM/FM STEREO

For greater spurious rejection the AM-RF amplifier circuit includes a three section variable tuning capacitor in the metal enclosed shielded RF module which also houses the FM-RF front end. The AM circuit has constant sensitivity, constant selectivity, high image rejection across the complete AM band. This circuit design achieves equal sensitivity even down at the low end of the band. Spurious, image, and intermediate

frequency rejection are all superior. The McIntosh circuit is unique in a superheterodyne AM receiver.

A high-quality loopstick antenna is provided. It can be rotated for maximum performance, optimum signal reception or minimum interference. Each loopstick is individually Tuned for optimum performance. After tuning The loopstick is then sealed. Custom matching of the loopstick to the AM-RF front end maximizes the performance of the loopstick antenna.

RELIABILITY AND IDEAL FLEXIBILITY...

STEREO CONTROL CENTER

TUNER PREAMPLIFIER

Performance Limits

FM

USABLE SENSITIVITY: 2.5 microvolts at 100% modulation (± 75 kHz deviation) for less than 3% total noise and harmonic distortion,

SIGNAL TO NOISE RATIO: 70 dB at 100% modulation,

HARMONIC DISTORTION: Mono: Will not exceed 0.3% at 100% modulation ± 75 kHz deviation. Stereo: Will not exceed 0.5% at 100% modulation ± 75 kHz deviation.

FREQUENCY RESPONSE: ± 1 dB from 20 Hz to 15,000 Hz with standard de-emphasis (75mS) and 19,000 Hz pilot filter.

CAPTURE RATIO: 1.5 dB

SPURIOUS REJECTION: 90dB

IMAGE REJECTION: 95 dB at 88 to 108 MHz (IHF)

STEREO SEPARATION: Exceeds 35 dB at 1,000 Hz.

SELECTIVITY: Switch Setting: OUT IN

Adjacent Channel: 6dB 15dB

Alternate Channel: 58 dB 88 dB

TUNING INDICATOR: D'Arsonval movement meter with increased sensitivity.

STEREO INDICATOR: Stereo light activated by 19,000 Hz pilot signal only.

AM

SENSITIVITY: 75 microvolts at 1,000 kHz (using external antenna input).

SIGNAL TO NOISE RATIO: 45 dB

HARMONIC DISTORTION: 1% at 30% modulation.

FREQUENCY RESPONSE: Down 6dB at 3,500 Hz.

SELECTIVITY: Switch Setting: OUT IN

Adjacent Channel: 35 dB 45 dB

IMAGE REJECTION: 65 dB; 540 kHz to 1600 kHz

PREAMPLIFIER

FREQUENCY RESPONSE: ± 0.5 dB, 20 to 20,000 Hz.

DISTORTION: Will not exceed 0.1% at 2.5 volts output, 20 to 20,000 Hz.

INPUT SENSITIVITY AND IMPEDANCE:

Phono 1 and Phono 2: 2 millivolts for 2.5 volts output at 1,000 Hz, 47,000 ohms; Auxiliary and Tape: 0.25 volts for 2.5 volts output; 250,000 ohms.

VOLTAGE AMPLIFICATION:

Phono 1, Phono 2 to Main output 62 dB, to Tape output 42 dB. Auxiliary, Tape to Main output 20 dB to Tape output 0 dB.

OUTPUT:

Main: 2.5 volts with rated input. Up to 10 volts can be developed without increase in distortion. FM will produce 10 volts output at 100% modulation. Tape: 0.25 volts with rated input. Phono signal to 10 millivolts produces 1.2 volts output. FM will produce 1 volt output at 100% modulation. L + R 2 volts with rated input.

HUM AND NOISE:

Phono 1 and Phono 2: 72 dB below 10 millivolt input; equivalent to less than 3 microvolts at the input terminals. Aux-Tape: 85 dB below 2.5 volts output, unweighted.

BASE CONTROL: -18 dB to +16 dB at 20 Hz.

TREBLE CONTROL: ± 20 dB at 20,000 Hz.

LF FILTER: Flat or roll off below 50 Hz, down 12 dB at 20 Hz.

HF FILTER: Flat or roll off above 5,000 Hz, down 12 dB at 20,000Hz.

POWER REQUIREMENTS: 120 volts, 50/60 Hz, 30 watts

TRANSISTOR COMPLEMENT:

2-JFET

3-MOSFET

30—Silicon Planar

31-Diodes

2—Integrated Circuits (each contains the equivalent of 16 transistors and 8 diodes).

FACILITIES AND FEATURES

VOLUME CONTROL: Precision "tracked" at all listening levels. (0 to -65 dB). Does not change stereo balance as loudness is changed. The AC power ON/OFF switch is coupled with this control.

BALANCE CONTROL: Natural balance at center position, attenuation of left or right channel by rotating control.

LOUDNESS: Loudness compensated or flat response—Loudness position boosts low frequencies for low level listening. Operates as a function of volume control position. Full compensation is obtained at lower volume levels and flat response is obtained at full volume.

SELECTIVITY: Increases the ability of the tuner to separate a weak (distant) station from a strong (local) station on adjacent channels.

MODE: Selects either stereo or mono operation.

PHASE CONTROL: Electronically reverses phase in the left channel to correct "out of phase" program sources.

MUTING: Suppresses the background noise and hiss normally heard between FM stations.

TAPE MONITOR: Pushbutton; compares recorded tape with program source while recording.

MUTING ADJUST: Modifies the noise rejection threshold on FM.

DIAL SCALE INTENSITY; Modifies the brightness of the illumination of the front panel.

MECHANICAL

SIZE: Front panel: 16 inches wide (40.64 cm) by 5-7/16 inches high (13.81 cm); Chassis: 15 inches wide (38.1 cm) by 13 inches deep (33.02 cm), including PANLOC shelf and back panel connectors, Knob Clearance: 1-1/2 inches (3.81 cm) in front of mounting panel.

FINISH: Front panel: Anodized gold and black with special gold/teal panel nomenclature illumination; Chassis: Chrome and black.

MOUNTING: McIntosh developed professional PANLOC.

WEIGHT: 26 pounds (11.79 kg) net, 38 pounds (17.24 kg) in shipping carton.



Shown in walnut veneer cabinet

MA 6100Here is performance once associated only with separate preamps and power amps

The MA 6100 delivers McIntosh performance and quality in a combination solid state preamplifier and solid state power amplifier. The stereo preamplifier has the lowest hum and noise of any combination unit.

The MA 6100 reproduces music accurately. There is no fuzziness. Here is the power you need to give you the sound of five music in your home.

The Silicon rectifiers power supply has instant response to the amplifiers needs. Recovery from the loudest musical passage is instantaneous. The music sounds alive and thrilling, not clouded by power supply under design.

McIntosh audio power ratings are in accordance with the Federal Trade Commission Regulation of November 4, 1974 concerning power output claims for amplifiers used in home entertainment products.

Performance Limits

POWER OUTPUT:

70 watts minimum sine wave continuous average power output, per channel, both channels operating into 8 ohms load impedance, which is:

23.7 volts RMS across 8 ohms

40 watts minimum sine wave continuous average power output, per channel, both channels operating into 16 ohms load impedance, which is:

25.3 volts RMS across 16 ohms

60 watts minimum sine wave continuous average power output, per channel, both channels operating into 4 ohms load impedance, which is:

15.49 volts RMS across 4 ohms

OUTPUT LOAD IMPEDANCE:

4 ohms, 8 ohms, or 16 ohms

RATED POWER BAND:

20 Hz to 20,000 Hz

TOTAL HARMONIC DISTORTION:

0.2% maximum harmonic distortion at any power level from 250 milliwatts to rated power per channel from 20 Hz to 20,000 Hz, both channels operating

INTERMODULATION DISTORTION:

0.2% if instantaneous peak power output is twice rated continuous average power or less per channel with both channels operating for any combination of frequencies 20 Hz to 20,000 Hz

FREQUENCY RESPONSE: (at one watt output)

20 Hz to 20,000 Hz +0 -0.5 dB

NOISE AND HUM:

power Amplifier; 95 dB below rated output

Aux, Tape, Tuner: 90 dB below rated output

Phono Input, Tape Hd.: 76 dB below 10 mV input

OUTPUT VOLTAGE:

At TAPE output:

Aux, Tape, Tuner: 300 mV with rated input

Phono: 300 mV with rated input; 1.2 volts with 1.0 mV input at 1000 Hz

Tape Hd: 300 mV at 500 Hz with rated input

DAMPING FACTOR:

50 at 3 ohms output

100 at 16 ohms output

INPUT SENSITIVITY AND IMPEDANCE:

Power Amplifier: 3 volts, 100,000 ohms

Phono 1 and Phono 2: 2.5 mV at 1000 Hz, 47,000 ohms

Tape Head: 3 mV, 47,000 ohms

Tape, Aux, and Tuner: 300 mV, 250,000 ohms

BASS CONTROLS:

+16 dB to -16 dB at 20 Hz

TREBLE CONTROLS:

+16 dB to -16 dB at 20,000 Hz

L.F. FILTER:

Active filter, 12 dB per octave roll off below 50 Hz; 20 dB down at 20 Hz

H.F. FILTER:

Active filter, 12 dB per octave roll off above 7000 Hz; 20 dB down at 20,000 Hz

GENERAL

SEMICONDUCTOR COMPLEMENT:

36 Silicon Transistors, 22 Silicon Rectifiers and Diodes, 2 Silicon Bilateral Switches, 2 Triac

POWER REQUIREMENTS:

170 volts, 50/60 Hz, 70 watts at zero signal output, 400 watts at rated output

FACILITIES AND FEATURES

COMPENSATION SWITCH:

Three position switch for FLAT, LOUOness, or PRESEnce. LOUOness boosts low frequencies for low level listening. PRESEnce boosts mid frequencies 4 dB to increase "presence" effect

TAPE INPUT/MONITOR SWITCHES:

Either of two tape recorders can be played or monitored

TAPE COPY SWITCH:

Two tape recorders can be connected to copy from tape machine 1 to tape machine 2 or vice versa

HEADPHONE JACK:

For listening with low impedance dynamic stereo headphones

MECHANICAL

SIZE:

Front panel measures 16 inches wide (40.64) by 5-7/16 inches high (13.81 cm). Chassis measures 15 inches wide (38.1 cm) by 13 inches deep (33.02 cm), including PANLOC shelf and back panel connectors. Knob clearance required is 1-1/2 inches (3.81 cm) in front of mounting panel

FINISH:

Front Panel: Anodized gold and black with special gold/teal panel nomenclature illumination

WEIGHT:

34 pounds (15.42 kg) net, 46 pounds (20.87 kg) in shipping carton

WHAT MAKES A GOOD MUSIC SYSTEM GREAT?

...DELICATE MUSICAL PASSAGES ARE REPRODUCED WITH CLEANNESS-
THUNDEROUS CRESCENDOS WITH ALL THE INSTRUMENTS CLEARLY DEFINED-
AND RESERVE ENERGY TO GO FROM ONE TO THE OTHER WITHOUT TAXING
THE SYSTEM---THESE ARE WHAT MCINTOSH AMPLIFIERS CAN DO FOR YOU.

McIntosh amplifiers have been the "LABORATORY STANDARD" in vacuum electronics for 20 years. McIntosh audio scientists have generated solid state innovations that have continued the McIntosh reputation for "LABORATORY STANDARD". New levels of performance, even greater reliability, and highest quality have created levels of cleanness and beauty in music that until now have been clouded by lower performance standards.

MCINTOSH ENGINEERING MAKES THE DRAMATIC DIFFERENCE

Continuing research is a way of life at McIntosh. "State of the Art" is not satisfactory. Engineering and experimentation without limits probe the present day boundaries of instrument performance. This expensive, far reaching program profits you by producing the best performance, greatest reliability, useful flexibility and long trouble free life. Careful examination of space age advances in electronics, new manufacturing developments and twenty years of experience in producing the "BEST" has given McIntosh the leadership in Solid State Electronics.

Performance in an amplifier comes from low distortion and high power capability. McIntosh solid state electronic amplifiers are guaranteed not to exceed 25/100 of 1% distortion at all audio frequencies at all power levels up to full rated power with both channels operating. Typical measurements are less than 1/10 of 1%!

You will hear all there is to hear with a clarity and naturalness never before achieved. And this performance is guaranteed!

Only McIntosh gives you a money back guarantee on performance. Every McIntosh instrument must be capable of meeting its advertised performance limits or you get a refund of your purchase price. McIntosh promises performance. We either meet our promise or you get your money back.

With a McIntosh you get full power output at all speaker impedances. Full power and full power response at all speaker impedances comes from a McIntosh development, the MCINTOSH TRIFILAR UNITY COUPLED AUTOFORMER. Using a McIntosh developed trifilar winding technique, and careful interleaving of the windings makes the autoformer a near perfect matching device for all loudspeakers, dynamics and electrostatic.

You get FULL POWER AT ALL SPEAKER IMPEDANCES.

Reliability and long trouble free life comes, in part, from McIntosh Sentry Monitoring Circuits.

The SENTRY MONITORING CIRCUIT prevents failure of the power transistors due to excessive mismatch of the output. With the amplifier operating normally the SENTRY MONITORING CIRCUIT has no effect on the signals passing through the power amplifiers. If the power dissipation should rise above normal, the SENTRY MONITORING CIRCUIT restricts the drive voltage to the output transistors. The SENTRY MONITORING CIRCUIT acts instantaneously. You are assured of complete circuit reliability. McIntosh is the only amplifier with this degree of protection.

To permit you to measure the performance, provide for correct system balance, and to obtain accurate power readings McIntosh has developed DYNAMIC PEAK LOCKING METERS.

Ordinary meters lack the capability of indicating the short interval power in a sound wave. The mass of the meter movement is too great to respond to instantaneous changes in music program material. Superior McIntosh engineering has developed new circuits that permits the meters to respond to the short interval power in sound wave to an accuracy of 98% of the true value.

Two new circuits were required to provide the accuracy. The first circuit is an accelerating circuit. It compensates for the inertia characteristics of the meter movement. The second circuit is a "time stretching" circuit. Short interval power fluctuation is so rapid that the eye might not perceive the instantaneous power reading. The "time stretching" circuit holds the meter needle at peak reading for a few milliseconds to permit the eye to perceive. The DYNAMIC PEAK LOCKING METERS represent another major engineering advancement by McIntosh audio scientists.

And best of all - you are protected for THREE FULL YEARS from any service costs. With the purchase of a McIntosh you are offered a FREE THREE YEAR SERVICE CONTRACT. You can't pay us for the repair of a McIntosh for the first three years you own it!

McIntosh is the best in PERFORMANCE, RELIABILITY, AND VALUE.



MONO POWER AMPLIFIER MC 50

POWER OUTPUT:

50 watts minimum sine wave continuous average power output, operating into 4 ohms, 8 ohms, or 16 ohms load impedance, which is:

14.1 volts RMS across 4 ohms
20.0 volts RMS across 8 ohms
28.3 volts RMS across 16 ohms

OUTPUT LOAD IMPEDANCE:

4 ohms, 8 ohms, or 16 ohms; separate terminals are provided for each output

RATED POWER BAND:

20 Hz to 20,000 Hz

TOTAL HARMONIC DISTORTION:

0.25% maximum harmonic distortion at any power level from 250 milliwatts to 50 watts from 20 Hz to 20,000 Hz

INTERMODULATION DISTORTION:

Will not exceed 0.25% if instantaneous peak power output is 100 watts or less for any combination of frequencies 20 Hz to 20,000 Hz

FREQUENCY RESPONSE: (at one watt output)

20 Hz to 20,000 Hz +0 - 0.25 dB
10 Hz to 100,000 Hz +0 - 3.0 dB

NOISE AND HUM:

90 dB below rated output

NOISE AND HUM:

90 dB below rated output

OUTPUT IMPEDANCE:

4, 8, or 16 ohms

OUTPUT VOLTAGES:

25 volts for distribution lines

DAMPING FACTOR:

25 at 4 ohms output
50 at 8 ohms output
17 at 16 ohms output

INPUT IMPEDANCE:

200,000 ohms

INPUT SENSITIVITY:

0.5 volt. Level control provided for higher input voltage

GENERAL

POWER REQUIREMENTS:

120 volts, 50/60 Hz, 15 watts at zero signal output, 120 watts at rated output

SEMICONDUCTOR COMPLEMENT:

12 silicon transistors
12 silicon rectifiers and diodes

MECHANICAL

SIZE:

5-1/2 inches high (13.97 cm), 8 inches wide (20.32 cm), 12-1/2 inches deep (31.75 cm)

CHASSIS:

Chrome and black

WEIGHT:

20 pounds (9.07 kg) net, 24 pounds (10.89 kg) in shipping carton

McIntosh audio power ratings are in accordance with the Federal Trade Commission Regulation of November 4, 1974 concerning power output claims for amplifiers used in home entertainment products.

PERFORMANCE GUARANTEE-

Performance limits are the maximum deviation from perfection permitted for a McIntosh instrument. We promise that the instrument you buy must be capable of performance at or exceeding its limits or you get your money back. McIntosh is the only manufacturer that makes this guarantee.



STEREO POWER AMPLIFIER MC 250

POWER OUTPUT:

Stereo:

50 watts minimum sine wave continuous average power output, per channel, both channels operating into 4 ohms, 8 ohms, or 16 ohms load impedance, which is:

- 14.1 volts RMS across 4 ohms
- 20.0 volts RMS across 8 ohms
- 28.3 volts RMS across 16 ohms

Mono:

100 watts minimum sine wave continuous average power output, operating into 2 ohms, 4 ohms, or 8 ohms load impedance, which is:

- 14.1 volts RMS across 2 ohms
- 20.0 volts RMS across 4 ohms
- 28.3 volts RMS across 8 ohms

OUTPUT LOAD IMPEDANCE:

Stereo: 4 ohms, 8 ohms, or 16 ohms; separate terminals are provided for each output; Mono: 2 ohms, 4 ohms, or 8 ohms; separate terminals are provided for each output

RATED POWER BAND:

20 Hz to 20,000 Hz

TOTAL HARMONIC DISTORTION:

Stereo:

0.25% maximum harmonic distortion at any power level from 250 milliwatts to 50 watts per channel from 20 Hz to 20,000 Hz, both channels operating

Mono:

0.25% maximum harmonic distortion at any power level from 250 milliwatts to 100 watts from 20 Hz to 20,000 Hz

INTERMODULATION DISTORTION:

Stereo:

0.25% if instantaneous peak power output is 100 watts or less per channel with both channels operating for any combination of frequencies 20 Hz to 20,000 Hz

Mono:

0.25% if instantaneous peak power output is 200 watts or less for any combination of frequencies 20 Hz to 20,000 Hz

FREQUENCY RESPONSE: (at one watt output)

20 Hz to 20,000 Hz +0 -0.25 dB

NOISE AND HUM:

90 dB below rated output

OUTPUT IMPEDANCE:

STEREO 4, 8, and 16 ohms

MONO 2, 4, and 8 ohms

OUTPUT VOLTAGES:

25 volts for distribution lines

DAMPING FACTOR:

15 at 4 ohms output

38 at 8 ohms output

17 at 16 ohms output

INPUT IMPEDANCE:

200,000 ohms

INPUT SENSITIVITY:

0.5 volt. Level control provided for higher input voltage

GENERAL

POWER REQUIREMENTS:

120 volts, 50/60 Hz, 50 watts at zero signal output, 250 watts at rated output

SEMICONDUCTOR COMPLEMENT:

24 silicon transistors

18 silicon rectifiers and diodes

MECHANICAL

SIZE:

7-1/16 inches high (17.94 cm), 10-5/8 inches wide (26.99 cm), 15-5/8 inches deep (39.69 cm)

CHASSIS:

Chrome and black

WEIGHT:

36 pounds (16.33 kg) net, 40 pounds (18.18 kg) in shipping carton



STEREO POWER AMPLIFIER MC 2100

POWER OUTPUT:

Stereo:

105 watts minimum sine wave continuous average power output, per channel, both channels operating into 4 ohms, 8 ohms, or 16 ohms load impedance, which is:

- 20.5 volts RMS across 4 ohms
- 29.0 volts RMS across 8 ohms
- 41.0 volts RMS across 16 ohms

Mono:

210 watts minimum sine wave continuous average power output, operating into 2 ohms, 4 ohms, or 8 ohms load impedance, which is:

- 20.5 volts RMS across 2 ohms
- 29.0 volts RMS across 4 ohms
- 41.0 volts RMS across 8 ohms

OUTPUT LOAD IMPEDANCE:

Stereo: 4 ohms, 8 ohms, or 16 ohms; separate terminals are provided for each output; Mono: 2 ohms, 4 ohms, or 8 ohms; separate terminals are provided for each output

RATED POWER BAND:

20 Hz to 20,000 Hz

TOTAL HARMONIC DISTORTION:

Stereo:

0.25% maximum harmonic distortion at any power level from 250 milliwatts to 105 watts per channel from 20 Hz to 20,000 Hz, both channels operating

Mono:

0.25% maximum harmonic distortion at any power level from 250 milliwatts to 210 watts from 20 Hz to 20,000 Hz

INTERMODULATION DISTORTION:

Stereo:

0.25% if instantaneous peak power output is 210 watts or less per channel with both channels operating for any combination of frequencies 20 Hz to 20,000 Hz

Mono:

0.25% if instantaneous peak power output is 420 watts or less for any combination of frequencies 20 Hz to 20,000 Hz

FREQUENCY RESPONSE: (at one watt output)

20 Hz to 20,000 Hz +0 -0.25 dB

NOISE AND HUM:

90 dB or more below rated output

OUTPUT IMPEDANCE:

STEREO 4, 8, and 16 ohms

MONO 2, 4, and 8 ohms

OUTPUT VOLTAGES:

25 volts for distribution lines

DAMPING FACTOR:

20 at 4 ohms output

14 at 8 ohms output

11 at 16 ohms output

INPUT IMPEDANCE:

200,000 ohms

INPUT SENSITIVITY:

0.5 volt. Level control provided for higher input voltage

GENERAL

POWER REQUIREMENTS:

120 volts, 50/60 Hz, 50 watts at zero signal output, 450 watts at rated output

SEMICONDUCTOR COMPLEMENT:

32 silicon transistors

14 silicon rectifiers and diodes

MECHANICAL

SIZE:

7-3/4 inches high (19.69 cm), 11-3/4 inches wide (29.85 cm), 17 inches deep (43.18 cm)

CHASSIS:

Chrome and black

WEIGHT:

57 pounds (25.86 kg) net, 63 pounds (28.58 kg) in shipping carton

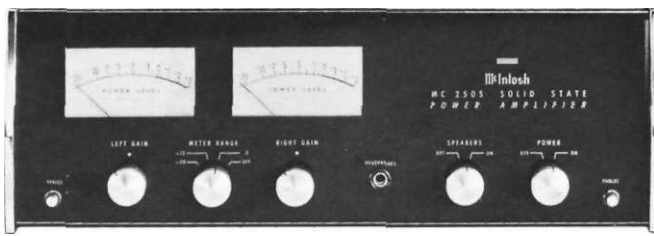

STEREO POWER AMPLIFIER NIC 2505

POWER OUTPUT:

50 watts minimum sine wave continuous average power output, per channel, both channels operating into 4 ohms, 8 ohms, or 16 ohms load impedance, which is:

- 14.1 volts RMS across 4 ohms
- 20.0 volts RMS across 8 ohms
- 28.3 volts RMS across 16 ohms

OUTPUT LOAD IMPEDANCE:

4 ohms, 8 ohms, or 16 ohms; separate terminals are provided for each output

RATED POWER BAND:

20 Hz to 20,000 Hz

TOTAL HARMONIC DISTORTION:

0.25% maximum harmonic distortion at any power level from 250 milliwatts to 50 watts per channel from 20 Hz to 20,000 Hz, both channels operating

INTERMODULATION DISTORTION:

0.25% if instantaneous peak power output is 100 watts or less per channel with both channels operating for any combination of frequencies 20 Hz to 20,000 Hz

FREQUENCY RESPONSE: (at one watt Output)

20 Hz to 20,000 Hz +0 -0.25 dB
10 Hz to 100,000 Hz +0 -3.0 dB

NOISE AND HUM:

90 dB below rated output

OUTPUT POWER MONITOR METER:

Meter range switch is provided to increase meter sensitivity by 10 dB or 20 dB. Calibration accuracy at 0 dB reading is +2% at all frequencies; meter range accuracy is ±5%

OUTPUT IMPEDANCE:

4, 8, and 16 ohms

OUTPUT VOLTAGES:

25 volts for distribution lines

HEADPHONE OUTPUT:

Designed for low impedance dynamic phones

DAMPING FACTOR:

14 at 4 ohms
27 at 8 ohms output
13 at 16 ohms output

INPUT IMPEDANCE/SENSITIVITY:

200,000 ohms; 0.5 volt. Level control provided for higher input voltage

CONTROLS:

AC Power ON/OFF switch, Speaker ON/OFF switch, Left gain, Right gain, and Meter range switch

GENERAL

POWER REQUIREMENTS:

120 volts, 50/60 Hz, 75 watts at zero signal output, 250 watts at rated output

SEMICONDUCTOR COMPLEMENT:

26 silicon transistors; 27 silicon rectifiers and diodes

MECHANICAL

SIZE:

Front panel measures 16 inches wide (40.64 cm) by 5-7/16 inches high (13.81 cm). Chassis measures 15 inches wide (38.1 cm) by 5 inches high (12.7 cm) by 13 inches deep (33.02 cm), including connectors. Knob connectors. Knob clearance required is 1-1/2 inches (3.81 cm) in front of mounting panel.

FINISH:

Panel is glass with anodized gold and black trim specially illuminated.

MOUNTING:

Exclusive McIntosh developed professional PANLOC

WEIGHT:

38 pounds (17.24 kg) net, 53 pounds (24.04 kg) in shipping carton

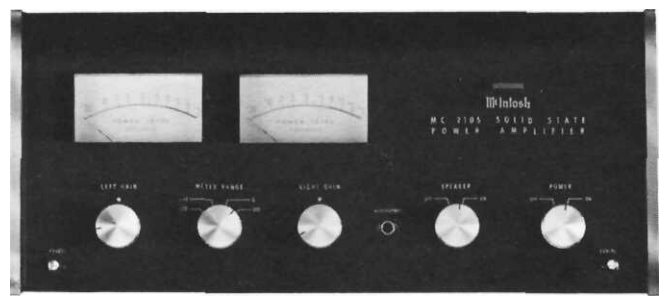

STEREO POWER AMPLIFIER MC 2105

POWER OUTPUT

105 watts minimum sine wave continuous average power output, per channel, both channels operating into 4 ohms, 8 ohms, or 16 ohms load impedance, which is:

- 20.5 volts RMS across 4 ohms
- 29.0 volts RMS across 8 ohms
- 41.0 volts RMS across 16 ohms

OUTPUT LOAD IMPEDANCE:

4 ohms, 8 ohms, or 16 ohms; separate terminals are provided for each output

RATED POWER BAND:

20 Hz to 20,000 Hz

TOTAL HARMONIC DISTORTION:

0.25% maximum harmonic distortion at any power level from 250 milliwatts to 105 watts per channel from 20 Hz to 20,000 Hz, both channels operating

INTERMODULATION DISTORTION:

0.25% if instantaneous peak power output is 210 watts or less per channel with both channels operating for any combination of frequencies 20 Hz to 20,000 Hz

FREQUENCY RESPONSE: (at one watt output)

20 Hz to 20,000 Hz +0 -0.25 dB
10 Hz to 100,000 Hz +0 -3.0 dB

NOISE AND HUM:

90 dB below rated output

OUTPUT POWER MONITOR METER:

Meter range switch is provided to increase meter sensitivity by 10 dB or 20 dB. Calibration accuracy at 0 dB reading is ±2% at all frequencies; meter range accuracy is ±5%

OUTPUT IMPEDANCE:

4, 8, and 16 ohms

OUTPUT VOLTAGES:

25 volts for distribution lines

HEADPHONE OUTPUT:

Designed for low impedance dynamic phones

DAMPING FACTOR:

18 at 4 ohms output
13 at 8 ohms output
10 at 16 ohms output

INPUT IMPEDANCE/SENSITIVITY:

200,000 ohms; 0.5 volt. Level control provided for higher input voltage

CONTROLS:

AC Power ON/OFF switch, Speaker ON/OFF switch, Left gain, Right gain, and Meter range switch

GENERAL

POWER REQUIREMENTS:

120 volts, 50/60 Hz, 75 watts at zero signal output, 430 watts at rated output

SEMICONDUCTOR COMPLEMENT:

34 silicon transistors; 18 silicon rectifiers and diodes

MECHANICAL

SIZE:

Front panel measures 16-3/16 inches wide (41.12 cm) by 7-1/8 inches high (13.1 cm). Chassis measures 15 inches wide (38.1 cm) by 6-9/16 inches high (16.67 cm) by 14-1/2 inches deep (36.83 cm), including connectors. Knob clearance required is 1-1/2 inches (3.81 cm) in front of mounting panel.

FINISH:

Front panel is anodized gold and black with special gold/teal nomenclature illumination. Chassis is chrome and black.

MOUNTING:

Exclusive McIntosh developed professional PANLOC

WEIGHT:

65 pounds (29.48 kg) net, 77 pounds (34.93 kg) in shipping carton

HEAR ALL THERE IS TO HEAR

STEREO POWER AMPLIFIER MC 2300

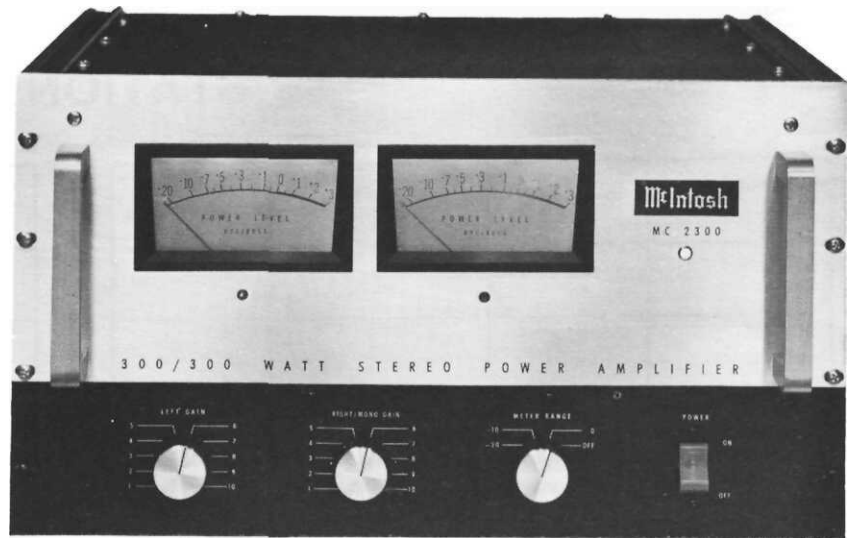

POWER OUTPUT:

Stereo:

300 watts minimum sine wave continuous average power output, per channel, both channels operating into 0.5 ohm, 1 ohm, 2 ohms, 4 ohms, 8 ohms, or 16 ohms load impedance, which is:

- 12.2 volts RMS across 0.5 ohm
- 17.3 volts RMS across 1 ohm
- 24.5 volts RMS across 2 ohms
- 34.6 volts RMS across 4 ohms
- 49.0 volts RMS across 8 ohms
- 69.3 volts RMS across 16 ohms

Mono:

600 watts minimum sine wave continuous average power output into 0.25 ohm, 0.50 ohm, 1 ohm, 2 ohms, 4 ohms, or 8 ohms load impedance, which is:

- 12.2 volts RMS across 0.25 ohm
- 17.3 volts RMS across 0.5 ohm
- 24.5 volts RMS across 1 ohm
- 34.6 volts RMS across 2 ohms
- 49.0 volts RMS across 4 ohms
- 69.3 volts RMS across 8 ohms

OUTPUT LOAD IMPEDANCE:

Stereo: 0.5 ohm, 1 ohm, 2 ohms, 4 ohms, 8 ohms, 16 ohms; separate terminals are provided for each output; Mono: 0.25 ohm, 0.5 ohm, 1 ohm, 2 ohms, 4 ohms and 8 ohms; separate terminals are provided for each output

RATED POWER BAND:

20 Hz to 20,000 Hz

TOTAL HARMONIC DISTORTION:

Stereo:

0.25% maximum harmonic distortion at any power level from 250 milliwatts to 300 watts per channel from 20 Hz to 20,000 Hz, both channels operating

Mono:

0.25% maximum harmonic distortion at any power level from 250 milliwatts to 600 watts from 20 Hz to 20,000 Hz

INTERMODULATION DISTORTION:

Stereo:

0.25% if instantaneous peak power is 600 watts or less per channel with both channels operating for any combination of frequencies 20 Hz to 20,000 Hz

Mono:

0.25% if instantaneous peak power is 1200 watts or less for any combination of frequencies 20 Hz to 20,000 Hz

FREQUENCY RESPONSE: (at one watt output)

Stereo:

- 20 Hz to 20,000 Hz, +0 - 0.5 dB; 1, 4, 8, or 16 ohms
- 20 Hz to 20,000 Hz, +0 - 1.0 dB; 0.5 or 2 ohms
- 12 Hz to 35,000 Hz, +0 - 1.5 dB

Mono:

- 20 Hz to 20,000 Hz, +0 - 0.5 dB; 0.5, 2, 4, or 8 ohms
- 20 Hz to 20,000 Hz, +0 - 1.0 dB; 0.25 or 1.0 ohms
- 12 Hz to 35,000 Hz, +0 - 1.5 dB

NOISE AND HUM:

90 dB below rated output

OUTPUT POWER MONITOR METER:

Meter is calibrated to read +3.0 dB when amplifier produces 300 watts. Meter range switch is provided to increase meter sensitivity by 10 dB or 20 dB. Calibration accuracy at 0 OB reading is $\pm 2.0\%$ at all frequencies; meter range accuracy is $\pm 5.0\%$

OUTPUT VOLTAGES: RATINGS

25 volts, stereo and mono; 70 volts, stereo and mono for distribution lines

DAMPING FACTOR:

27 at 0.5 ohm output, 50 at 1 ohm output, 29 at 2 ohms output, 21 at 4 ohms output, 14 at 8 ohms output

INPUT IMPEDANCE:

200,000 ohms

INPUT SENSITIVITY:

0.5 volt. Level control provided for higher input voltage

GENERAL

POWER REQUIREMENTS:

120 volts, 50/60 Hz, 160 watts at zero signal output, 1400 watts at rated output

SEMICONDUCTOR COMPLEMENT:

- 46 silicon transistors
- 1/ silicon rectifiers and diodes

MECHANICAL

SIZE:

Front panel measures 19 inches wide (48.26 cm) by 10-1/2 inches high (26.67 cm). Chassis measures 14 inches wide (43.18 cm) by 10 inches high (25.4 cm) by 17 inches deep (43.18 cm), including connectors. Clearance in front of mounting panel including knobs 2 inches (5.08 cm)

FINISH:

Front panel is anodized gold and black. Chassis is black baked enamel.

MOUNTING:

Standard 19" (48.26 cm) rack mounting

WEIGHT:

128 pounds (58.06 kg) net, 143 pounds (64.86 kg) in shipping carton

SPECIAL FEATURES:

The amplifier is completely stable when connected to any loudspeaker system and to any reactive loads. The MC 2300 has special circuits to prevent damage by short circuit or open circuit of the output loads, or by any amount of output impedance mismatch.

Thermal cutouts are mounted on the output transistor heat sinks to provide protection in the event of inadequate ventilation. Peak reading—peak locking meters feature special circuits that respond to the peak values of complex input signals.

McIntosh

McINTOSH LABORATORY INC.
2 CHAMBERS ST., BINGHAMTON, N. Y. 13903
607-723-3512

Printed in U.S.A.

038-961